



NOMAD™

OPERATION MANUAL

PWR-FLO™

**1" POLYPROPYLENE PUMP
PWR-FLO™ AIR DISTRIBUTION SYSTEM
NPF 25A**





AIR-OPERATED  DOUBLE DIAPHRAGM  PUMPS





A JDA Global Company

 **CAUTION:** Do not apply compressed air to the exhaust port – pump will not function.

 **CAUTION:** Do not over-lubricate air supply – excess lubrication will reduce pump performance. Pump is pre-lubed.

 **TEMPERATURE LIMITS:**
 Neoprene -17.7°C to 93.3°C 0°F to 200°F
 Buna-N -12.2°C to 82.2°C 10°F to 180°F
 EPDM -15.1°C to 137.8°C -60°F to 280°F
 NOTE: Not all materials are available for all models. Refer to Section 2 for material options for your pump.

 **CAUTION:** Check temperature limits for all wetted components. Example: Viton® has a maximum limit of 176.7°C (350°F) but polypropylene has a maximum limit of only 79°C (175°F).

 **CAUTION:** Maximum temperature limit are based upon mechanical stress only. Certain chemicals will significantly reduce maximum safe operating temperatures.

 **WARNING:** Prevention of static parking – if static sparking occurs, fire or explosion could result. Pump, valves, and containers must be grounded to a proper grounding point when handling flammable fluids and whenever discharge of static electricity is a hazard.

 **CAUTION:** Do not exceed 8.6 bar (125psig) air supply pressure.

 **CAUTION:** The process fluid and cleaning fluids must be chemically compatible with all wetted pump components.

 **CAUTION:** Do not exceed 82°C (180°F) air inlet temperature.

 **CAUTION:** Pumps should be thoroughly flushed before installing into process lines.

 **CAUTION:** Always wear safety glasses when operating pump. If diaphragm rupture occurs, material being pumped may be forced out air exhaust.

 **CAUTION:** Before any maintenance or repair is attempted, the compressed air line to the pump should be disconnected and all air pressure allowed to bleed from pump. Disconnect all intake, discharge and air lines. Drain the pump by turning it upside down and allowing any fluid to flow into a suitable container.

 **CAUTION:** Blow out air line for 10 to 20 seconds before attaching to pump to make sure all pipeline debris is clear. Use an in-line air filter. A 5µ (micron) air filter is recommended.

NOTE: When installing PTFE diaphragms, it is important to tighten outer pistons simultaneously (turning in opposite directions) to ensure a tight fit. (See torque specifications.)

NOTE: Before starting disassembly, mark a line from each liquid chamber to its corresponding air chamber. This line will assist in proper alignment during reassembly.

 **CAUTION:** Tighten all hardware prior to installation.

Pump Designation System



XXX XX / XXXX / XX / XX / XXX / X / X / X

1	2	3	4	5	6	7,8	9	10	11	12	13	ATEX
Air Distribution System	Liquid Port Size	Wetted Parts	Diaphragms & Valve Balls			Valve Seats	Fittings	Connections				
N	07	A	BN	A	BN	A	N	C				
T	15	W	ND	S	BN	B	B					
TG	25	S	NE	BN	TC	FL						
PF	40	P	TF	NE								
DF	50	4	VT	ND								
		A	FG	VT								
		W	SN	SP								
		S	SNF	FG								
		W	TFF	P								
		P	TGN	K								
		5	TGE	PU								
		A	TGV	MTF								
		P	PU	10								
		6	FGF	BN								
B	PUF	NE										
P		ND										

NTG 50 / AAAB / TF / TF / ATF / N / C / X

1	2	3	4	5	6	7,8	9	10	11	12	13	ATEX
Air Distribution System	Liquid Port Size	Wetted Parts	Diaphragms & Valve Balls			Valve Seats	Fittings	Connections				
N	50	A	TF	A	N	C						
T		4	10									
TG		A	TF									
PF		5										
DF		A										
		6										
		B										

The NOMAD diaphragm pump is an air-operated, positive displacement, self-priming pump. These drawings show flow pattern through the pump upon its initial stroke. It is assumed the pump has no fluid in it prior to its initial stroke.

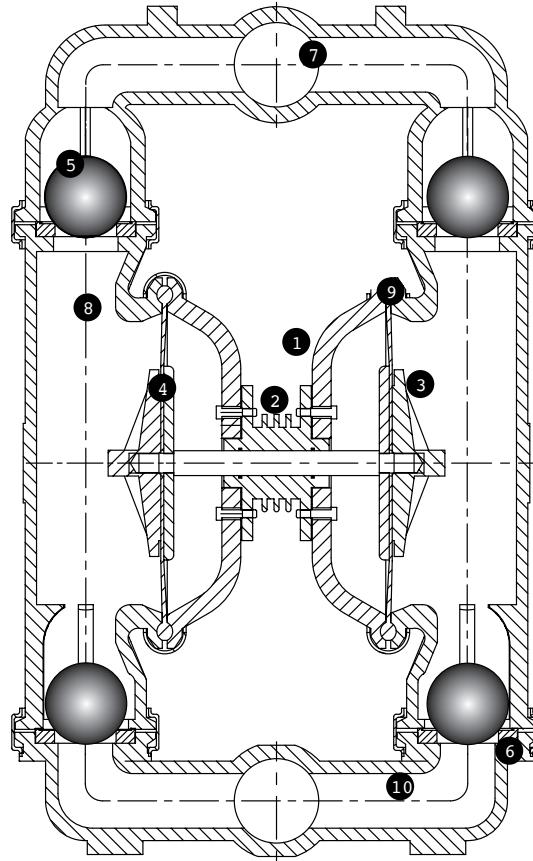

1. Air Chamber

The air chamber is the chamber that houses the air which powers the diaphragms.

2. Air Distribution System

The air distribution system is the heart of the pump. The air distribution system is the mechanism that shifts the pump in order to create suction and discharge strokes.

3. Lock Nut (Outer Diaphragm Piston)

The outer diaphragm pistons provide a means to connect the diaphragms to the reciprocating common shaft and to seal the liquid side from the air side of the diaphragm.

4. Holding plate (Inner Diaphragm Piston)

The inner piston is located on the air side of the pump and does not come into contact with the process fluid.

5. Check Valve Ball

NOMAD air-operated pumps use suction and discharge check valves to produce directional flow of process fluid in the liquid chamber. The check valve balls seal and release on the check valve seats allowing for discharge and suction of process fluid to occur.

6. Check Valve Seat

The removable seats provide the ball valves a site to check.

7. Discharge Manifold

Process fluid exits the pump from the discharge port located on the discharge manifold at the top of the pump.

8. Liquid Chamber

The liquid chamber is filled with the process fluid during the suction stroke and is emptied during the discharge stroke. It is separated from the compressed air by the diaphragms.

9. Diaphragm

The diaphragm membrane provides for separation of the process fluid and the compressed air power source. To perform adequately, diaphragms should be of sufficient thickness and of appropriate material to prevent degradation or permeation in specific process fluid applications. NOMAD offers a variety of diaphragm materials for your specific application requirements.

10. Inlet Manifold

Process fluid enters the pump from the intake port located on the inlet manifold at the bottom of the pump.

Troubleshooting

Pump will not run or runs slowly.

1. Ensure that the air inlet pressure is at least 0.4 Bar (5 psig) above start up pressure and that the differential pressure (the difference between air inlet and liquid discharge pressures) is not less than 0.7 Bar (10 psig).
2. Check air inlet filter for debris
3. Check for extreme air leakage (blow by) which would indicate worn seals/bores in the air valve.
4. Disassemble pump and check for obstructions in the air passageway.
5. Check for sticking ball check valves. If material being pumped is not compatible with pump, elastomer, swelling may occur. Replace ball check valves and seals with proper elastomers. Also, as the check valve balls wear out, they become smaller and can become stuck in the seats. In this case, replace balls and seats.
6. Check for broken inner piston which will cause the air valve spool to be unable to shift.
7. Remove plug from pilot spool exhaust.

Pump runs but little or no product flows.

1. Check for pump cavitation; slow pump speed down to allow thick material to flow into liquid chambers.
2. Verify that vacuum required to lift is not greater than the vapor pressure of the material being pumped (cavitation).
3. Check for sticking ball valves. If material being pumped is not compatible with pump elastomers, swelling may occur. Replace ball check valves and seats with proper elastomers. Also, as the check valve balls wear out, they become smaller and can become stuck in the seats. In this case, replace balls and seats.

Pump air valve freezes.

1. Check for excessive moisture in compressed air. Either install a dryer or hot air generator for compressed air. Alternatively, a coalescing filter may be used to remove the water from the compressed air in some applications.

Air bubbles in pump discharge.

1. Check for ruptured diaphragm.
2. Check tightness of outer pistons.
3. Check tightness of fasteners and integrity of o-rings and seals, especially at intake manifold.
4. Ensure pipe connections are airtight

Product comes out air exhaust.

1. Check for diaphragm rupture.
2. Check tightness of outer pistons to shaft.

INSTALLATION:

- Suction pipe equal to/greater than pump diameter (same for discharge)
- Tighten all fasteners before use
- Suction connection should be non-collapsible

AIR SUPPLY:

- Air line size must be large enough to create desired volume (see performance curve section)
- Do not exceed 8.6 BAR (125 PSIG)
- For best results, use 5 micron air filter
- Use lubricator with 5 wt. oil

PIPING:

- Remove as many turns/elbows as possible
- Piping should be supported
- Flexible hose will avoid stress on pump fitting
- Gate Valve should be used in applications involving flooded suction
- In positive suction head conditions, limit inlet pressure to 0.5 - 0.7 BAR (7 - 10 PSI). Premature diaphragm failure will take place above the parameters.

ALL NOMAD PUMPS ARE CAPABLE OF PASSING SOLIDS. A STRAINER SHOULD BE USED ON THE PUMP INTAKE TO ENSURE THAT THE PUMP'S RATED SOLIDS CAPACITY IS NOT EXCEEDED.

CAUTION: DO NOT EXCEED 8.6 BAR (125 PSIG) AIR SUPPLY PRESSURE.

Suggested Installation

This illustration is a generic representation of an air-operated double-diaphragm pump.

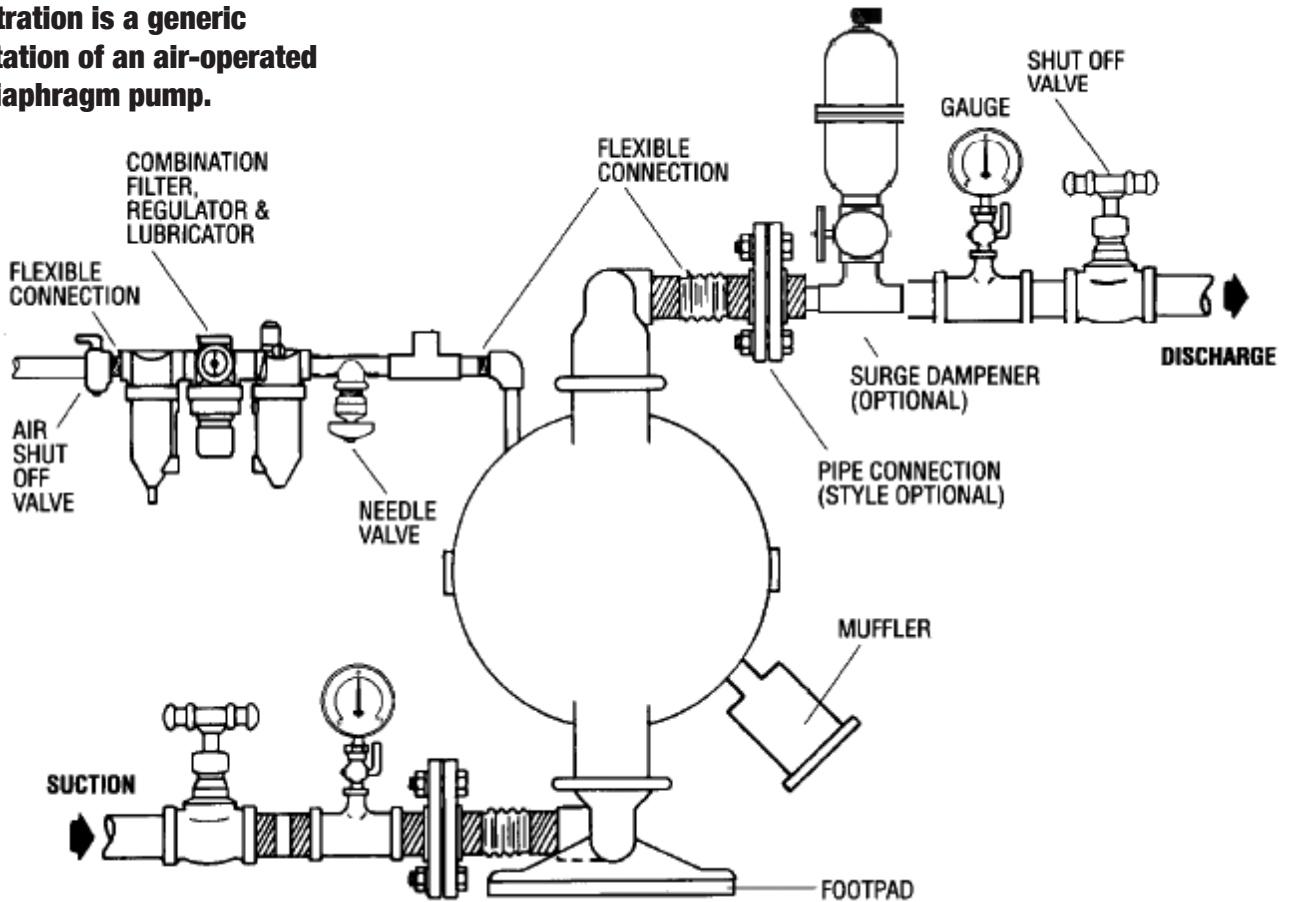

NOTE: In the event of a power failure, the shut off valve should be closed, if the restarting of the pump is not desirable once power is regained.

AIR OPERATED PUMPS: To stop the pump from operating in an emergency situation, simply shut off valve (user supplied) installed

in the air supply line. A properly functioning valve will stop the air supply to the pump, therefore stopping output. The shut off valve should be located far enough away from the pumping equipment such that it can be reached safely in an emergency situation.

PF25A

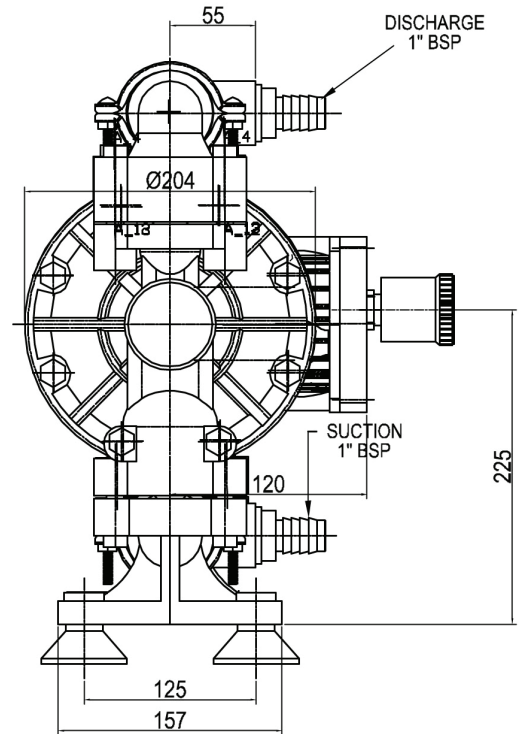
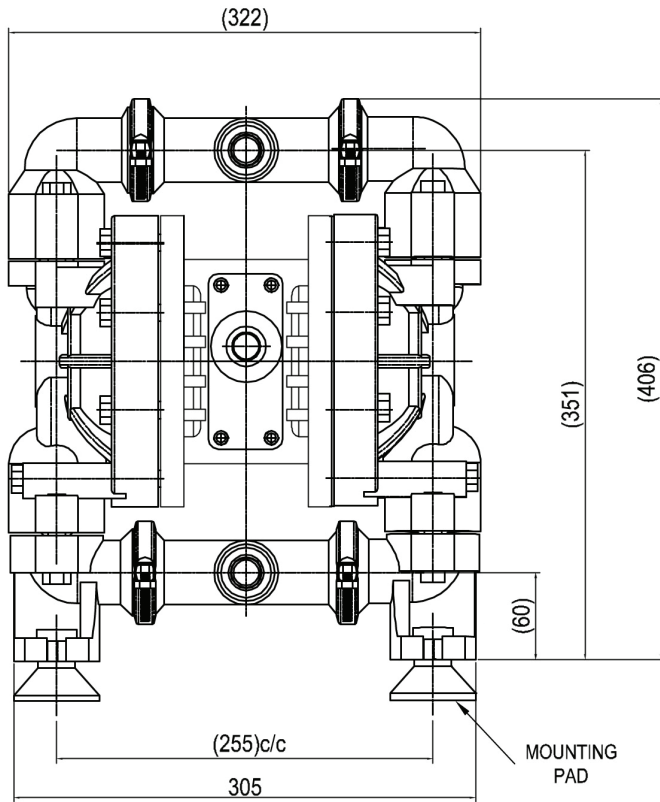

MUNTING PAD DETAIL

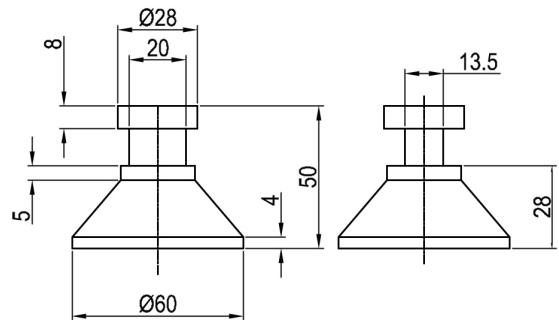

Flanged version available,
consult factory

NOTES :-

- 1) ALL DIMENSIONS ARE IN mm
- 2) GENERAL TOLERANCE ± 5 mm

SPECIFICATIONS

Max Flow Rate: 135Lpm (34gpm)
Port Size: Inlet: 25.40mm (1")
 Discharge: 25.40mm (1")
Air Inlet: 1/4"

Air Exhaust: 19.5mm

Suction Lift: Dry: 3.05m (10')

Wet: 4.89m (16')

Max Particle Size (Dia): 3.17mm (0.125")

PERFORMANCE

PF25A

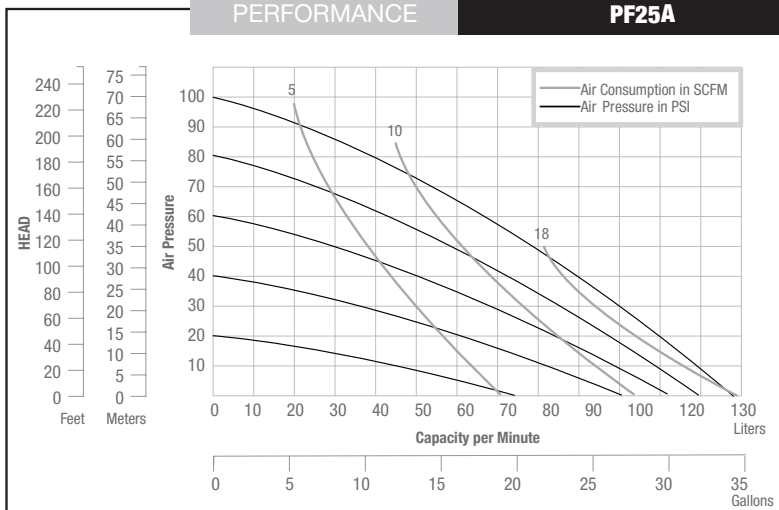

No.	Part Description	Qty.	Teflon-Fitted	Santoprene-Fitted
1	Center Section Assembly	1	T02--3141-20	
2	Slyder Seal	2	T02-3210-55-225	
3	Shaft	1	T02-3810-03	
4	Pilot Sleeve Assembly	1	T02-3880-99	
5	Inner Piston	2	T02-3751-01	T02-3701-01
6	Diaphragm	2	T02-1010-55	T02-1010-58
7	Outer Piston	2	T02-4570-20-500	T02-4550-20-500
8	Liquid Chamber	2	T02-5005-20	
9	Ball Cage	4	T01-5355-20	
10	Valve Ball	4	T02-1080-55	T02-1080-58
11	Valve Seat	4	T02-1125-20	
12	Seat O Ring	4	T02-1220-55	T02-1220-58
13	Suction Elbow	2	T02-5090-20	
14	Discharge Elbow	2	T02-5030-20	
15	Suction Discharge Tee	2	T02-5600-20	
16	Tee O Ring	4	T02-1205-55	
17	Air Valve Gasket	1	T01-2615-51	
18	Air Valve Assembly	1	T01-2010-20	
19	Air Valve Cap O Ring	1	T01-2395-51	
20	Air Valve Block Cap	1	T01-2332-20	
21	Air Valve Cover Gasket	1	T01-3505-51	
22	Air Valve Muffler Plate	1	T01-3181-20	
23	Muffler	1	T02-3510-20	
24	Liquid Chamber Bolts (small)	12	T02-6191-03	
25	Liquid Chamber Bolts (big)	4	T02-6192-03	
26	Suction Discharge Bend Bolts	8	T02-6181-03	
27	Air Valve Bolts	4	T01-6001-03	
28	Backup Diaphragm	2	T02-1060-51	

Exploded View & Parts Listing

N O M A D™

NPF25A

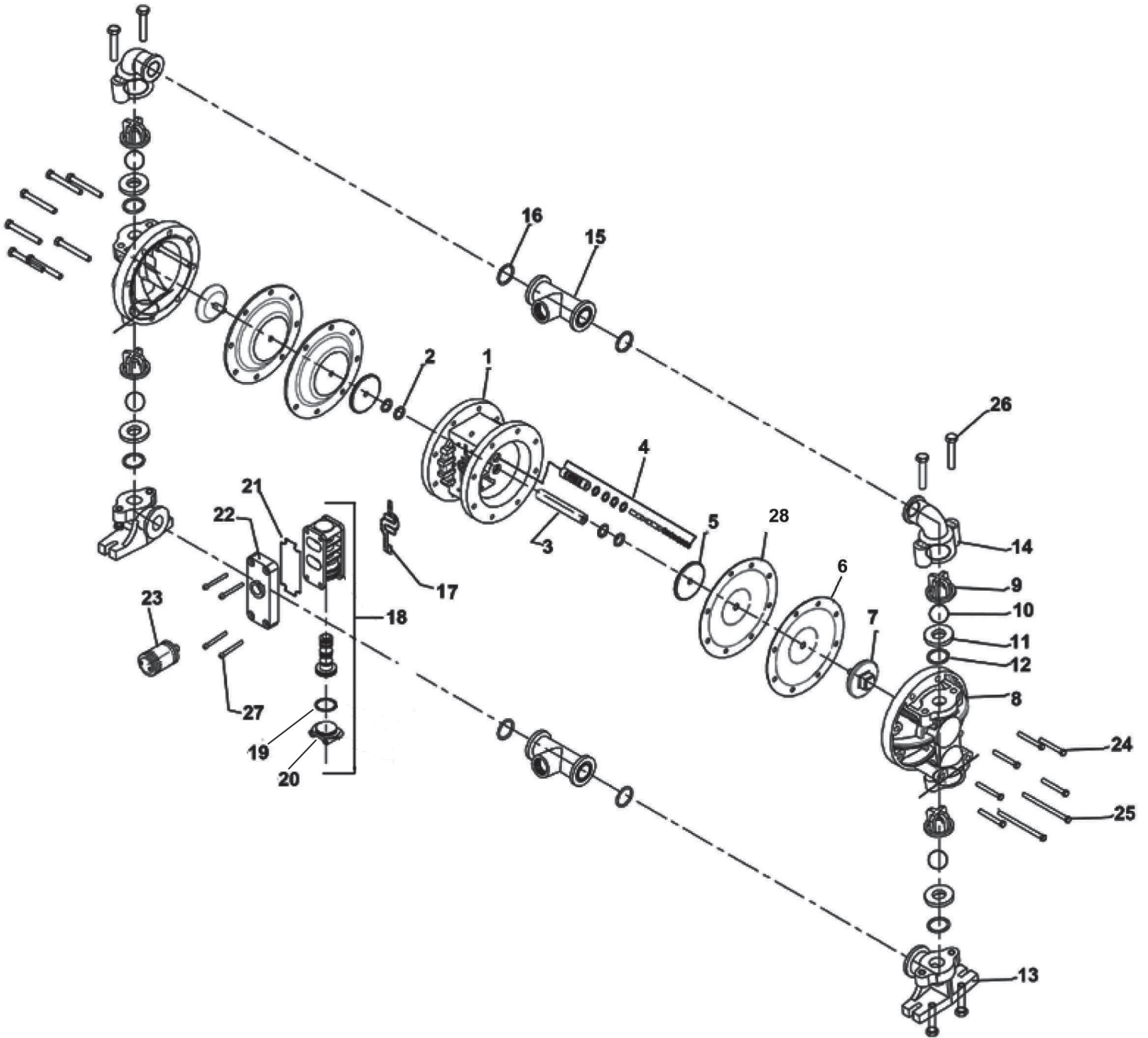



A JDA Global Company

1645 W. Park Ave., Suite 200
Redlands, CA USA 92373
(909) 798-9532

N O M A D



NO BOUNDARIES