



## SaniForce 2150e Electric-Operated Diaphragm Pump

3A5132C  
EN

2-Inch pumps with electric drive for fluid transfer applications.  
Not approved for use in explosive atmospheres or hazardous locations unless otherwise stated. See Approvals page for more information. For professional use only.



### Important Safety Instructions

Read all warnings and instructions in this manual and in your SaniForce 2150e Repair/Parts manual. **Save these instructions.**

*Maximum Working Pressure: 100 psi  
(0.69 MPa, 6.9 bar)*

*See page 7 for approvals.*

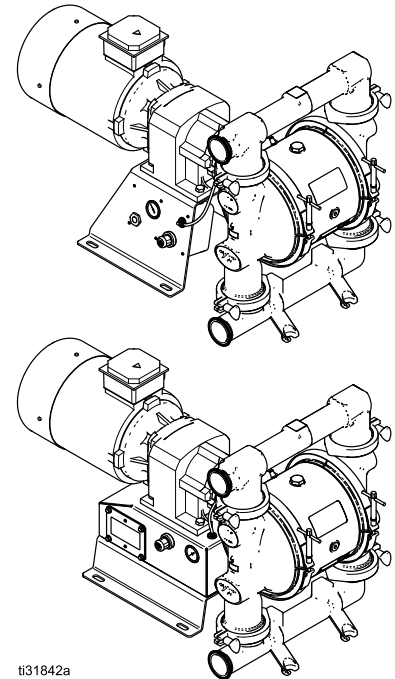

ti31842a

# Contents



Related Manuals .....	2	Transfer Mode Vs. Low Pulsation Mode .....	19
Warnings .....	3	Start and Adjust the Pump .....	19
Configuration Number Matrix .....	6	Pressure Relief Procedure .....	20
Ordering Information .....	8	Pump Shutdown .....	20
Installation .....	9	VFD Operation .....	21
General Information .....	9	VFD Control Panel .....	21
Tighten Clamps Before First Use .....	9	Adjust the Speed .....	21
Tips to Reduce Cavitation .....	9	Maintenance .....	22
Mount the Pump .....	12	Maintenance Schedule .....	22
Ground The System .....	13	Lubrication .....	22
Air Line .....	14	Tighten Connections .....	22
Fluid Supply Line .....	14	Flushing and Storage .....	22
Fluid Outlet Line .....	14	Performance Charts .....	23
Electrical Connections .....	15	Dimensions .....	26
Leak Sensor Wiring .....	17	Technical Data .....	29
Compressor Wiring .....	18	Graco Standard Warranty .....	34
Operation .....	19		
Initial Configuration (AC with VFD) .....	19		
Sanitize the Pump Before First Use .....	19		







## Related Manuals







Manual Number	Title
3A5133	SaniForce™ 2150e Electric-Operated Diaphragm Pump, Repair/Parts

# Warnings

The following warnings are for the setup, use, grounding, maintenance, and repair of this equipment. The exclamation point symbol alerts you to a general warning and the hazard symbols refer to procedure-specific risks. When these symbols appear in the body of this manual or on warning labels, refer back to these Warnings. Product-specific hazard symbols and warnings not covered in this section may appear throughout the body of this manual where applicable.

 <h1 style="margin: 0;">WARNING</h1>	
 	<p><b>ELECTRIC SHOCK HAZARD</b></p> <p>This equipment must be grounded. Improper grounding, setup, or usage of the system can cause electric shock.</p> <ul style="list-style-type: none"> <li>• Turn off and remove power before disconnecting any cables and before servicing or installing equipment. For cart-mounted models, unplug the power cord. For all other units, disconnect power at the main switch.</li> <li>• Connect only to grounded power source.</li> <li>• All electrical wiring must be done by a qualified electrician and comply with all local codes and regulations.</li> <li>• Wait five minutes for capacitor discharge before opening equipment.</li> </ul>
    	<p><b>FIRE AND EXPLOSION HAZARD</b></p> <p>Flammable fumes, such as solvent and paint fumes, in <b>work area</b> can ignite or explode. Paint or solvent flowing through the equipment can cause static sparking. To help prevent fire and explosion:</p> <ul style="list-style-type: none"> <li>• Use equipment only in well ventilated area.</li> <li>• Eliminate all ignition sources; such as pilot lights, cigarettes, portable electric lamps, and plastic drop cloths (potential static arc).</li> <li>• Ground all equipment in the work area. See <b>Grounding</b> instructions.</li> <li>• Keep work area free of debris, including solvent, rags and gasoline.</li> <li>• Do not plug or unplug power cords, or turn power or light switches on or off when flammable fumes are present.</li> <li>• Use only grounded hoses.</li> <li>• <b>Stop operation immediately</b> if static sparking occurs or you feel a shock. Do not use equipment until you identify and correct the problem.</li> <li>• Keep a working fire extinguisher in the work area.</li> </ul> <p>Static charge may build up on plastic parts during cleaning and could discharge and ignite flammable vapors. To help prevent fire and explosion:</p> <ul style="list-style-type: none"> <li>• Clean plastic parts only in well ventilated area.</li> <li>• Do not clean with a dry cloth.</li> <li>• Do not operate electrostatic guns in equipment work area.</li> </ul>

 <h1 style="margin: 0;">WARNING</h1>	
  	<p><b>PRESSURIZED EQUIPMENT HAZARD</b></p> <p>Fluid from the equipment, leaks, or ruptured components can splash in the eyes or on skin and cause serious injury.</p> <ul style="list-style-type: none"> <li>Follow the <b>Pressure Relief Procedure</b> when you stop spraying/dispensing and before cleaning, checking, or servicing equipment.</li> <li>Tighten all fluid connections before operating the equipment.</li> <li>Check hoses, tubes, and couplings daily. Replace worn or damaged parts immediately.</li> </ul>
 	<p><b>EQUIPMENT MISUSE HAZARD</b></p> <p>Misuse can cause death or serious injury.</p> <ul style="list-style-type: none"> <li>Do not operate the unit when fatigued or under the influence of drugs or alcohol.</li> <li>Do not exceed the maximum working pressure or temperature rating of the lowest rated system component. See <b>Technical Data</b> in all equipment manuals.</li> <li>Use fluids and solvents that are compatible with equipment wetted parts. See <b>Technical Data</b> in all equipment manuals. Read fluid and solvent manufacturer's warnings. For complete information about your material, request Safety Data Sheet (SDS) from distributor or retailer.</li> <li>Turn off all equipment and follow the <b>Pressure Relief Procedure</b> when equipment is not in use.</li> <li>Check equipment daily. Repair or replace worn or damaged parts immediately with genuine manufacturer's replacement parts only.</li> <li>Do not alter or modify equipment. Alterations or modifications may void agency approvals and create safety hazards.</li> <li>Make sure all equipment is rated and approved for the environment in which you are using it.</li> <li>Use equipment only for its intended purpose. Call your distributor for information.</li> <li>Route hoses and cables away from traffic areas, sharp edges, moving parts, and hot surfaces.</li> <li>Do not kink or over bend hoses or use hoses to pull equipment.</li> <li>Keep children and animals away from work area.</li> <li>Comply with all applicable safety regulations.</li> </ul>
	<p><b>PRESSURIZED ALUMINUM PARTS HAZARD</b></p> <p>Use of fluids that are incompatible with aluminum in pressurized equipment can cause serious chemical reaction and equipment rupture. Failure to follow this warning can result in death, serious injury, or property damage.</p> <ul style="list-style-type: none"> <li>Do not use 1,1,1-trichloroethane, methylene chloride, other halogenated hydrocarbon solvents or fluids containing such solvents.</li> <li>Do not use chlorine bleach.</li> <li>Many other fluids may contain chemicals that can react with aluminum. Contact your material supplier for compatibility.</li> </ul>

 <h1 style="margin: 0;">WARNING</h1>	
	<p><b>THERMAL EXPANSION HAZARD</b></p> <p>Fluids subjected to heat in confined spaces, including hoses, can create a rapid rise in pressure due to the thermal expansion. Over-pressurization can result in equipment rupture and serious injury.</p> <ul style="list-style-type: none"> <li>• Open a valve to relieve the fluid expansion during heating.</li> <li>• Replace hoses proactively at regular intervals based on your operating conditions.</li> </ul>
	<p><b>PLASTIC PARTS CLEANING SOLVENT HAZARD</b></p> <p>Many solvents can degrade plastic parts and cause them to fail, which could cause serious injury or property damage.</p> <ul style="list-style-type: none"> <li>• Use only compatible water-based solvents to clean plastic structural or pressure-containing parts.</li> <li>• See <b>Technical Data</b> in this and all other equipment instruction manuals. Read fluid and solvent manufacturer's Safety Data Sheet (SDS) and recommendations.</li> </ul>
	<p><b>TOXIC FLUID OR FUMES HAZARD</b></p> <p>Toxic fluids or fumes can cause serious injury or death if splashed in the eyes or on skin, inhaled, or swallowed.</p> <ul style="list-style-type: none"> <li>• Read Safety Data Sheet (SDS) to know the specific hazards of the fluids you are using.</li> <li>• Store hazardous fluid in approved containers, and dispose of it according to applicable guidelines.</li> </ul>
	<p><b>BURN HAZARD</b></p> <p>Equipment surfaces and fluid that's heated can become very hot during operation. To avoid severe burns:</p> <ul style="list-style-type: none"> <li>• Do not touch hot fluid or equipment.</li> </ul>
	<p><b>PERSONAL PROTECTIVE EQUIPMENT</b></p> <p>Wear appropriate protective equipment when in the work area to help prevent serious injury, including eye injury, hearing loss, inhalation of toxic fumes, and burns. This protective equipment includes but is not limited to:</p> <ul style="list-style-type: none"> <li>• Protective eyewear, and hearing protection.</li> <li>• Respirators, protective clothing, and gloves as recommended by the fluid and solvent manufacturer.</li> </ul>

# Configuration Number Matrix

Check the identification plate (ID) for the Configuration Number of your pump. Use the following matrix to define the components of your pump.

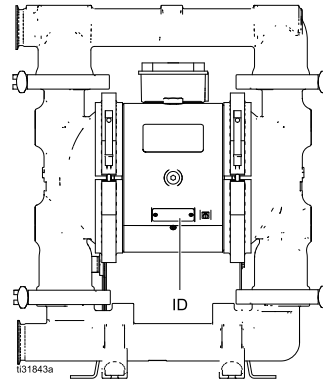

Sample Configuration Number: **2150T-E,A04AS1-3SSPTPTPT**







<b>2150</b>	<b>T</b>	<b>E</b>	<b>A</b>	<b>04</b>	<b>A</b>	<b>S1-3</b>	<b>SS</b>	<b>PT</b>	<b>PT</b>	<b>PT</b>
Pump Model	Wetted Section Material	Drive	Center Section Material	Gear Box and Compressor	Motor	Fluid Covers and Manifolds	Seats	Balls	Diaphragms	Manifold O-Rings

**NOTE:** Some combinations are not possible. Please refer to [Ordering Information, page 8](#).

Pump	Wetted Section Material		Drive Type		Center Section Material		Gearbox and Compressor		Motor	
	<b>2150</b>	<b>T</b>	Stainless steel, TriClamp	<b>E</b>	Electric	<b>A</b>	Aluminum	<b>94</b>	No Gearbox or Compressor	<b>A</b>
					<b>S</b>	Stainless Steel	<b>04</b>	High Speed Gear Ratio	<b>C</b>	ATEX Induction Motor
							<b>05</b>	High Speed Gear Ratio/120V Compressor	<b>D</b>	Flameproof Induction Motor
							<b>06</b>	High Speed Gear Ratio/240V Compressor	<b>G</b>	No Motor
							<b>14</b>	Mid Speed Gear Ratio		
							<b>15</b>	Mid Speed Gear Ratio/120V Compressor		
							<b>16</b>	Mid Speed Gear Ratio/240V Compressor		
							<b>24</b>	Low Speed Gear Ratio		
							<b>25</b>	Low Speed Gear Ratio/120V Compressor		
							<b>26</b>	Low Speed Gear Ratio/240V Compressor		

Configuration Number Matrix

Fluid Covers and Manifolds		Seat Material		Ball Material		Diaphragm Material		Manifold O-Rings	
<b>S1-3</b>	Stainless steel, TriClamp	<b>SS</b>	316 Stainless Steel	<b>CW</b>	Polychloroprene Weighted	<b>PT</b>	PTFE/EPDM 2-Piece	<b>EP</b>	EPDM
<b>S1-4</b>	Stainless steel, DIN			<b>PT</b>	PTFE	<b>SP</b>	Santoprene	<b>PT</b>	PTFE
				<b>SP</b>	Santoprene				

Approvals	
◆ Pumps with motor code <b>C</b> are certified to:	 II 2 G Ex h d IIB T3 Gb
✦ Pumps with motor code <b>G</b> are certified to:	 II 2 G Ex h IIB T3 Gb
★ Motors coded <b>D</b> are certified to:	 LISTED Class I, Div 1, Group D, T3B Class II, Div 1, Group F & G, T3B 
Ball materials coded <b>PT</b> and diaphragm materials coded <b>PO</b> or <b>PT</b> are certified to:	
All Models (except gearbox and compressor codes 05, 15, and 25, or motor code <b>D</b> ) are certified to:	

## Ordering Information

### To Find Your Nearest Distributor

1. Visit [www.graco.com](http://www.graco.com).
2. Click on **Where to Buy** and use the **Distributor Locator**.

### To Specify the Configuration of a New Pump

Please call your distributor.





OR

Use the **Online Diaphragm Pump Selector Tool** at [www.graco.com](http://www.graco.com). Go to the **Process Equipment Page**.

### To Order Replacement Parts

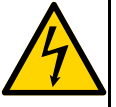
Please call your distributor.

# Installation

				
<p>Installation of this equipment involves potentially hazardous procedures. Only trained and qualified personnel who have read and who understand the information in this manual should install this equipment.</p> <ul style="list-style-type: none"> <li>All electrical wiring must be done by a qualified electrician and comply with all local codes and regulations</li> </ul>				

## General Information

The Typical Installation shown is only a guide for selecting and installing system components. Contact your Graco distributor for assistance in planning a system to suit your needs. Always use Genuine Graco Parts and accessories. Be sure all accessories are adequately sized and pressure rated to meet the system's requirements.

Reference letters in the text, for example (A), refer to the callouts in the figures.

## Tighten Clamps Before First Use

After you unpack the pump, and before you use it for the first time, check all clamps and tighten as necessary.

## Tips to Reduce Cavitation

Cavitation in a double diaphragm pump is the formation and collapse of bubbles in the pumped liquid. Frequent or excessive cavitation can cause serious damage, including pitting and early wear of fluid chambers, balls, and seats. It may result in reduced efficiency of the pump. Cavitation damage and reduced efficiency both result in increased operating costs.

Cavitation depends on the vapor pressure of the pumped liquid, the system suction pressure, and the velocity pressure. It can be reduced by changing any of these factors.

1. Reduce vapor pressure: Decrease the temperature of the pumped liquid.
2. Increase suction pressure:
  - a. Lower the installed position of the pump relative to the liquid level in the supply.
  - b. Reduce the friction length of the suction piping. Remember that fittings add friction length to the piping. Reduce the number of fittings to reduce the friction length.
  - c. Increase the size of the suction piping.

**NOTE:** Be sure the inlet fluid pressure does not exceed 25% of the outlet working pressure.
3. Reduce liquid velocity: Slow the cyclic rate of the pump.

Pumped liquid viscosity is also very important but normally is controlled by factors that are process dependent and cannot be changed to reduce cavitation. Viscous liquids are more difficult to pump and more prone to cavitation.

Graco recommends taking all the above factors into account in system design. To maintain pump efficiency, supply only enough power to the pump to achieve the required flow.

Graco distributors can supply site specific suggestions to improve pump performance and reduce operating costs.

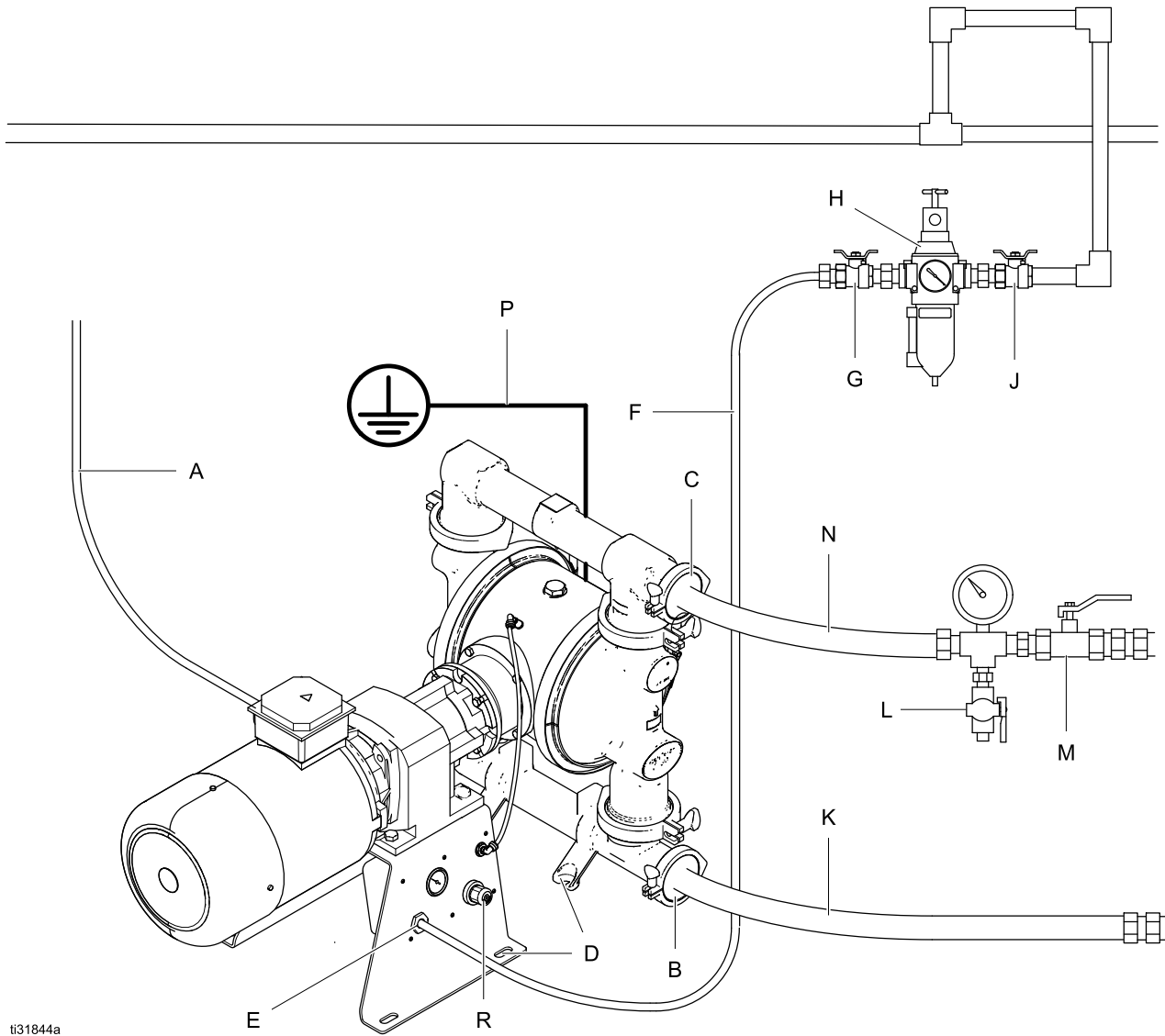

t31844a

Figure 1 Typical Installation for pumps without a compressor

**System Components**

- B Fluid inlet port
- C Fluid outlet port
- D Mounting feet
- E Air inlet port
- P Pump Ground
- R Center section regulator

**Accessories/Components Not Supplied**

- A\* Power cord to VFD
- F\* Grounded, flexible air supply line
- G Bleed-type master air valve
- H Air filter/regulator assembly
- J Master air valve (for accessories)
- K\* Grounded, flexible fluid supply line
- L Fluid drain valve (may be required for your pump installation)
- M Fluid shutoff valve
- N\* Grounded, flexible fluid outlet line

\* Required. Supplied by customer.

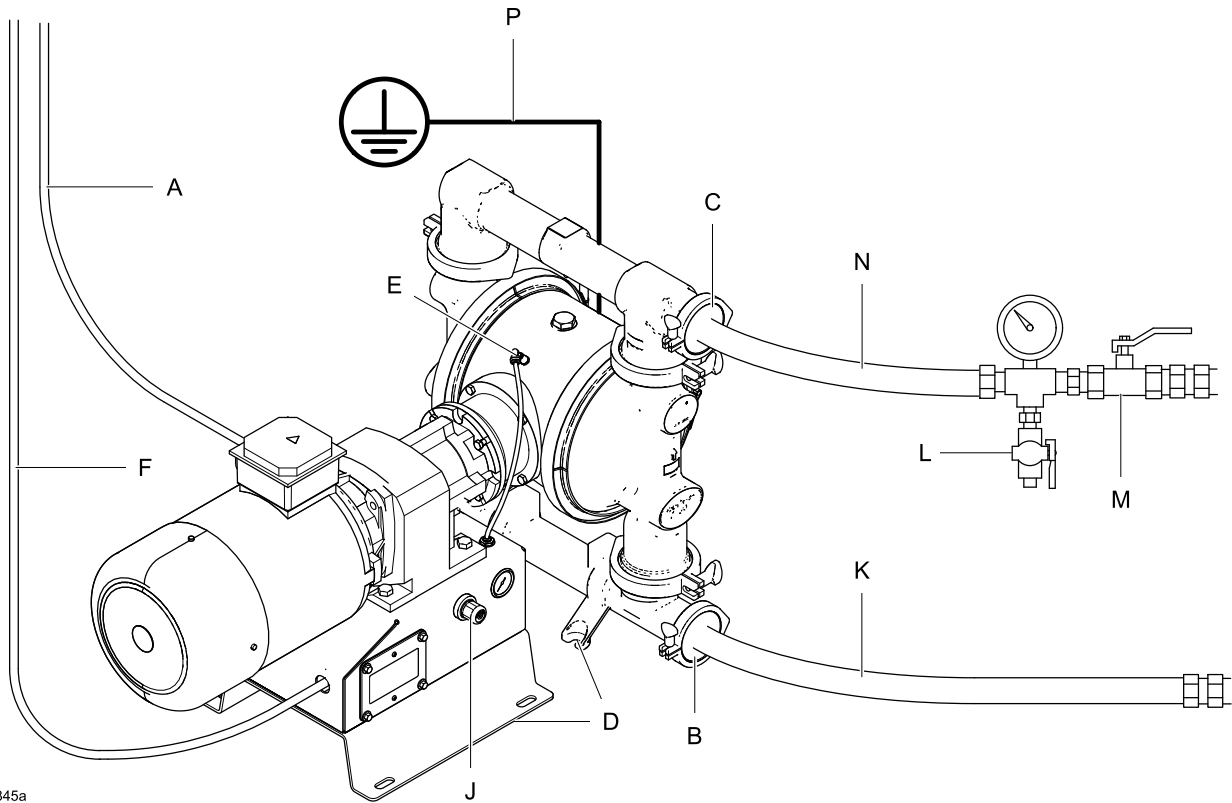

ti31845a

Figure 2 Typical installation of a pump with compressor

**System Components**

- B Fluid inlet port
- C Fluid outlet port
- D Mounting feet
- E Air inlet port
- J Center section regulator
- P Pump Ground

**Accessories/Components Not Supplied**

- A\* Power cord to VFD
  - F\* Power cord to compressor
  - K\* Grounded, flexible fluid supply line
  - L Fluid drain valve (may be required for your pump installation)
  - M Fluid shutoff valve
  - N\* Grounded, flexible fluid outlet line
- \* Required. Supplied by customer.

## Mount the Pump



To avoid serious injury or death from toxic fluid or fumes:

- Never move or lift a pump under pressure. If dropped, the fluid section may rupture. Always follow the [Pressure Relief Procedure, page 20](#), before moving or lifting the pump.

### NOTICE

The pump is heavy. To prevent damage from dropping, always use a lift to move the pump. Do not use the manifolds to lift the pump. Use at least two straps.

1. For all mountings, be sure the pump is secured with screws through the mounting feet (D) and through the mounting bracket or compressor box on the gear box. See [Dimensions, page 26](#).

### NOTICE

To prevent pump damage, use all eight fasteners.

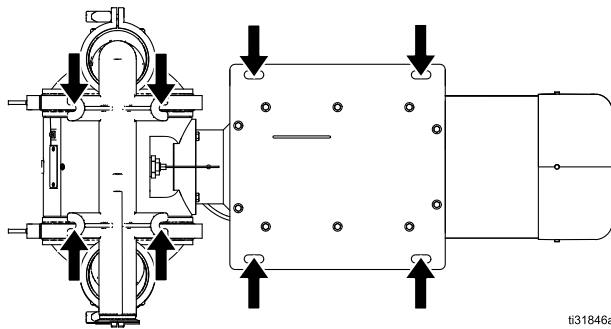

ti31846a

2. Make sure the mounting surface is flat and that the pump doesn't wobble.
3. For ease of operation and service, mount the pump so fluid inlet and fluid outlet ports are easily accessible.

## Mounting a pump without a Gearmotor

A pump without a Graco gearbox and motor will require a mounting platform to provide support for the customer-supplied motor and gearbox and provide alignment with the pump alignment housing (116) and drive shaft (112) without putting strain on the mounting platform or pump. See [Dimensions, page 26](#) for assistance in fabricating a mounting platform.

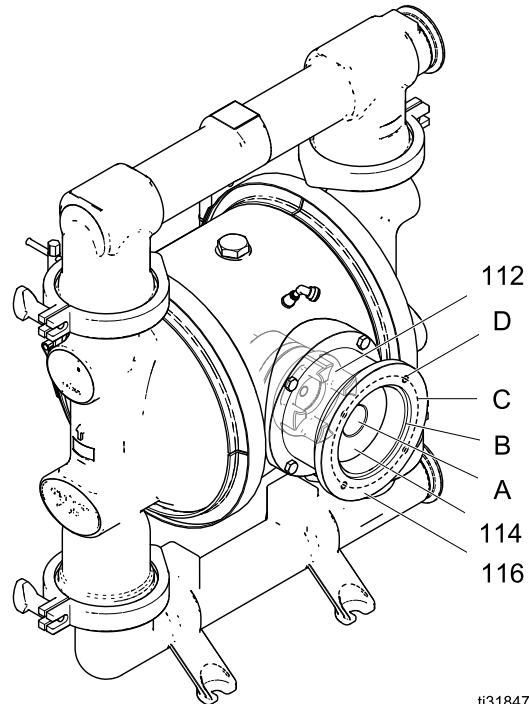





ti31847a

REF	DESCRIPTION	DIMENSION
A	Gearbox coupler bore and keyway	35 mm/10 mm keyway
B	Flange pilot diameter	110 mm
C	Bolt circle diameter	130 mm
D	Mounting hole thread size	M8 x 1.25

To specify a non-Graco gearbox, refer to the figure and table above.

## Ground The System

				
<p>The equipment must be grounded to reduce the risk of static sparking. Static sparking can cause fumes to ignite or explode. Improper grounding can cause electric shock. Grounding provides an escape wire for the electrical current.</p> <ul style="list-style-type: none"> <li>• <b>Always</b> ground the entire fluid system as described below.</li> <li>• Follow your local fire codes.</li> </ul>				

Before operating the pump, ground the system as explained below.

- **Pump:** All pumps have a ground screw. Loosen the grounding screw. Insert one end of a 12-gauge minimum ground wire behind the ground screw and tighten the screw securely. Connect the clamp end of the grounding wire to a true earth ground. A ground wire and clamp, Part 238909, is available from Graco.

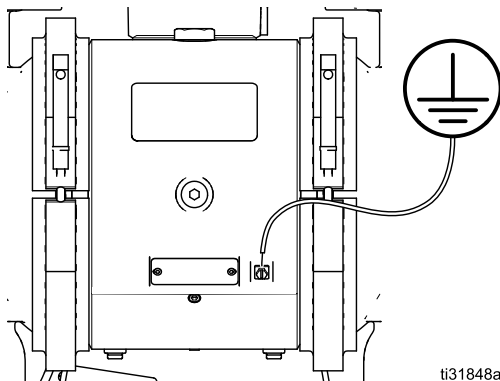

- **Motor:** Motors have a ground screw in the electrical box. Use it to ground the motor to the controller.

- **Air Line and Fluid hoses:** Use only grounded hoses with a maximum of 500 ft (150 m) combined hose length to ensure grounding continuity. Check electrical resistance of hoses. If total resistance to ground exceeds 29 megohms, replace hose immediately.
- **Fluid supply container:** Follow local code.
- **Solvent pails used when flushing:** Follow local code. Use only conductive metal pails, placed on a grounded surface. Do not place the pail on a nonconductive surface, such as paper or cardboard, which interrupts grounding continuity.
- **VFD:** Ground the variable frequency drive through a proper connection to a power source. Refer to the VFD manual for grounding instructions.

Check your system electrical continuity after the initial installation, and then set up a regular schedule for checking continuity to be sure proper grounding is maintained. The resistance should not exceed 1 ohm.

## Air Line

### Models that Include a Compressor:

An air line is already connected from the compressor to the pump air inlet.

### Using Your Own Compressor:

Install a grounded, flexible air hose from the compressor to the pump air inlet (E).

### Using Shop Air:

1. Install an air filter/regulator assembly (H). The fluid stall pressure will be the same as the setting of the air regulator. The filter removes harmful dirt and moisture from the compressed air supply.
2. Locate a bleed-type master air valve (G) close to the pump and use it to relieve trapped air. Be sure the valve is easily accessible from the pump and located downstream from the regulator.

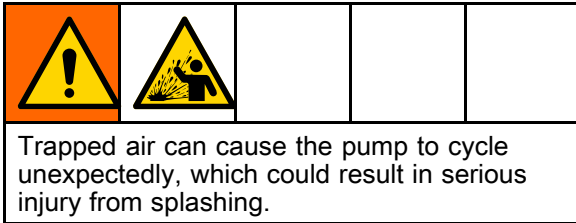

3. Locate another master air valve (J) upstream from all air line accessories and use it to isolate them during cleaning and repair.
4. Install a grounded, flexible air hose (F) between the accessories and the pump air inlet.

## Fluid Supply Line

1. Use flexible, grounded fluid hoses.
2. For best sealing results, use a standard tri-clamp or DIN style sanitary gasket of a flexible material such as EPDM, Buna-N, fluoroelastomer, or silicon.
3. If the inlet fluid pressure to the pump is more than 25% of the outlet working pressure, the ball check valves will not close fast enough, resulting in inefficient pump operation. Excessive inlet fluid pressure also will shorten diaphragm life. Approximately 3–5 psi (0.02–0.03 MPa, 0.21–0.34 bar) should be adequate for most materials.
4. For maximum suction lift (wet and dry), see [Technical Data, page 29](#). For best results, always install the pump as close as possible to the material source. Minimize suction requirements to maximize pump performance.

## Fluid Outlet Line

1. Use flexible, grounded fluid hoses.
2. For best sealing results, use a standard tri-clamp or DIN style sanitary gasket of a flexible material such as EPDM, Buna-N, fluoroelastomer, or silicon.
3. Install a fluid drain valve (L) near the fluid outlet.
4. Install a shutoff valve (M) in the fluid outlet line.

## Electrical Connections



### Wire Connections at the Motor (Motor Code A)

**NOTE:** Follow the instructions in the motor manufacturer's manual. Use a motor starter with overload protection. Wire size, fuse size, and other electrical devices must comply with all local codes and regulations.

The motor must be wired to the VFD. Install the wiring at the motor as follows:

1. Remove 4 bolts to open the motor's electrical box.
2. Install a strain relief in one of the ports at the bottom of the junction box.
3. Connect the green ground wire to the ground screw.
4. **For 230 V motors:** Bridge as shown, then connect L1 to T1, L2 to T2, and L3 to T3.

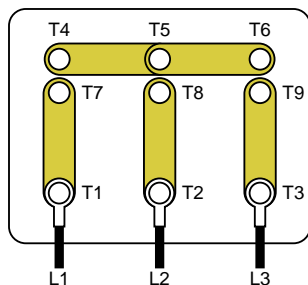

Figure 3 Wire Connections for a 230 V Motor

5. **For 460 V motors:** Bridge as shown, then connect L1 to T1, L2 to T2, and L3 to T3.

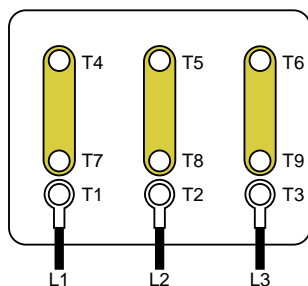

Figure 4 Wire Connections for a 460 V Motor

6. Close the motor electrical box. Torque the bolts to 20 in-lb (2.2 N•m).

### Wire Connections at the ATEX Motor (Motor Code C)

Install the wiring at the motor as follows:

1. Open the motor's electrical box.
2. Install wiring system with proper connections to the motor electrical box.
3. Connect the green ground wire to the ground screw.
4. **For 400V Wiring:** Bridge as shown, then connect wire L1 to U1, L2 to V1, and L3 to W1.

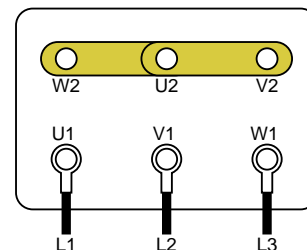

Figure 5 Connections for 400V Wiring

5. **For 230V Wiring:** Connect wire L1 to U1, L2 to V1, and L3 to W1. Bridge as shown.

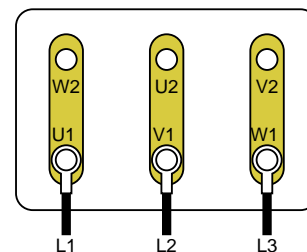

Figure 6 Connections for 230V Wiring

6. Torque terminals to 20 in-lb (2.3 N•m).
7. Close the motor electrical box. Torque the screws to 20 in-lb (2.3 N•m).
8. Connect thermostat wires P1 and P2 to external overload detection. Thermostat is NC (normally closed).

### Wire Connections at the Explosionproof Motor (Motor Code D)

Install the wiring at the motor as follows:

1. Open the motor's electrical box.
2. Install wiring system with proper connections to the motor electrical box.
3. Connect the green ground wire to the ground screw.
4. **For 460V Wiring:** Connect wire L1 to T1, L2 to T2, and L3 to T3, and bridge the other wires, as shown.

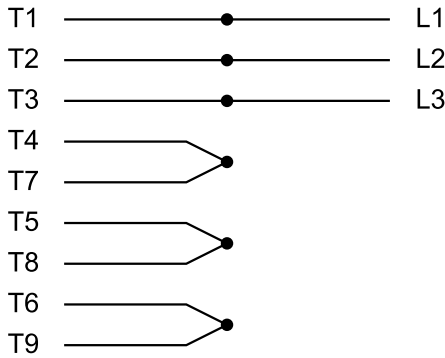

Figure 7 Connections for 460V Wiring

5. **For 230V Wiring:** Bridge the wires as shown. Then, connect L1 to T1/T7, L2 to T2/T8, and L3 to T3/T9.

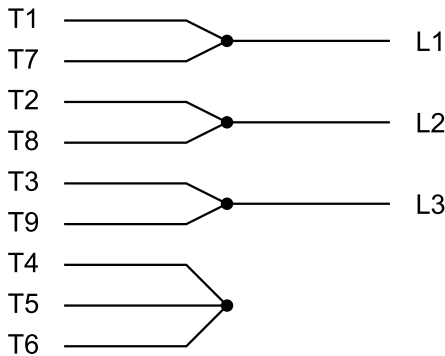

Figure 8 Connections for 230V Wiring

6. Connect thermostat wires P1 and P2 to external overload detection. Thermostat is NC (normally closed).
7. Close the motor electrical box. Torque the screws to 20 in-lb (2.3 N•m).

### Wire Connections at the Variable Frequency Drive (VFD)

**NOTE:** Follow the instructions in the VFD manufacturer's manual.

Install the wiring at the VFD as follows:

1. Connect the wires to the motor. See [Electrical Connections, page 15](#).
2. Open the VFD's electrical box.
3. Install strain reliefs in both ports at the bottom of the VFD box.
4. Connect the green ground wire to the ground screw.
5. Connect the wires from the motor terminals to the matching terminals in the VFD box, as shown.

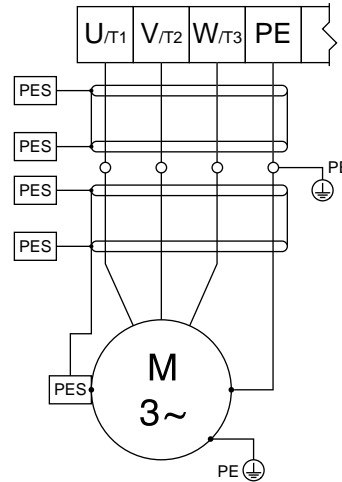
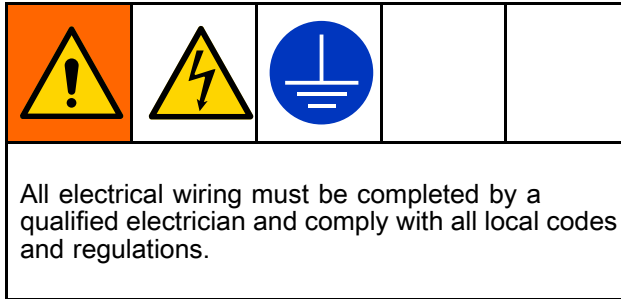

Figure 9 Wire Connections from the Motor to the VFD

## Main Power Connections at the VFD



Connect the power supply wires to the VFD, as follows:

1. Connect the wiring between the motor and VFD, as detailed above.
2. Connect the green ground wire of the power supply to the ground screw. The ground wire from the motor is also connected to this screw.
3. Connect the power supply wires to the power terminals in the VFD box, following all local codes and regulations.
4. Close the VFD electrical box.

## Leak Sensor Wiring





Follow these instructions to wire the Leak Sensor to a VFD.

**NOTE:** The leak sensor is designed to operate as a normally-closed circuit.

1. Turn off power to the VFD.
2. Open the access cover on the VFD.
3. For a Graco VFD, perform the following:
  - a. Wire one lead to terminal 4 on the rail.
  - b. Wire a second lead to terminal 13A on the rail.
  - c. Close the access cover.
  - d. Turn on power to the VFD.
  - e. Go to screen P121.
  - f. Change the value to 21 and press the Mode button.
4. For a non-Graco VFD, perform the following:
  - a. Attach the two leads to the detection circuit in the VFD.
 

**NOTE:** Refer to the VFD manual for proper connection points.
  - b. Close the access cover.
  - c. Turn on power to the VFD.
  - d. Configure the VFD to monitor the leak sensor circuit.
5. Refer to the VFD manual for information on how to configure the VFD to generate a fault or stop the pump when a leak is detected.

## Compressor Wiring

				
<p>To avoid injury from fire, explosion, or electric shock, all electrical wiring must be done by a qualified electrician and comply with all local codes and regulations.</p>				

Follow these instructions to wire Graco Compressor 24Y544 (120V) or 24Y545 (240V).

**NOTE:** Use only copper wire with an insulation rating of 75°C or higher.

1. Remove the cover from the compressor's electrical box.

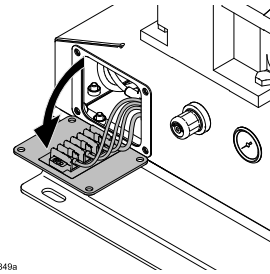
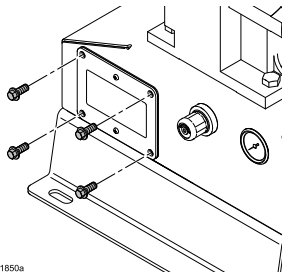

2. Install wiring system with proper connections (i.e. conduit/fittings, power cable/cable grip) to the compressor electrical box.
3. Connect line power (120VAC or 240 VAC, depending on your compressor) to L1 and L2/N.

Connect supply ground to . Use minimum 12 AWG (4 mm<sup>2</sup>) wire when the system is configured for a 16A circuit and 14 AWG (2.5 mm<sup>2</sup>) when configured for a 12A circuit. Torque terminals to 10 in-lb (1.2 N•m).

4. Reinstall the cover of the electrical box. Torque screws to 60 in-lb (6.8 N•m).

Figure 10

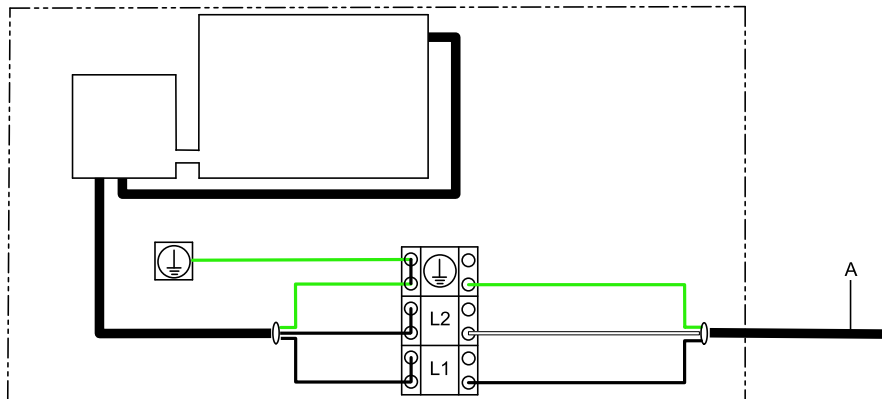

**KEY**

A To power supply

# Operation



## Initial Configuration (AC with VFD)

Configure the VFD according to the motor nameplate information.

## Sanitize the Pump Before First Use

It is the user's responsibility to properly sanitize the pump before first use. It is up to the user whether this will include disassembling and cleaning individual parts or simply flushing pump with a sanitizing solution. As necessary, follow the steps under [Start and Adjust the Pump, page 19](#), or [Flushing and Storage, page 22](#).

## Transfer Mode Vs. Low Pulsation Mode

When the air pressure is at least 10 psi higher than the desired outlet pressure, the pump is in Transfer Mode and no pulsation damping is occurring. To reduce outlet pulsation, start by setting the air pressure *equal* to the desired outlet fluid pressure. Continue to adjust the air pressure relative to the outlet fluid pressure. Lower relative air pressures produce more pulsation damping. Higher relative air pressures produce better pump efficiency.

## Start and Adjust the Pump

1. Be sure the pump is properly grounded. See [Ground The System, page 13](#).
2. Check fittings to be sure they are tight. Use a compatible liquid thread sealant on male threads. Tighten fluid inlet and fluid outlet fittings securely.
3. Place the suction tube (if used) in fluid to be pumped.

**NOTE:** If fluid inlet pressure to the pump is more than 25% of outlet working pressure, the ball check valves will not close fast enough, resulting in inefficient pump operation.

### NOTICE

Excessive fluid inlet pressure can reduce diaphragm life.

4. Place the end of the fluid hose into an appropriate container.
5. Close the fluid drain valve.
6. Turn the air regulator knob to match the desired fluid stall pressure. Open all bleed-type master air valves.
7. If the fluid hose has a dispensing device, hold it open. Be sure all fluid shutoff valves are open.
8. Set the desired frequency on the VFD.
9. Press the start (run) button on the VFD.
10. If you are flushing, run the pump long enough to thoroughly clean the pump and hoses.

## Pressure Relief Procedure



Follow the Pressure Relief Procedure whenever you see this symbol.



This equipment stays pressurized until pressure is relieved manually. To help prevent serious injury from pressurized fluid, such as splashing in the eyes or on skin, follow the Pressure Relief Procedure when you stop pumping and before you clean, check, or service the equipment.

1. Remove power from the system.
2. Open the dispensing valve, if used.
3. Open the fluid drain valve (L), if used, to relieve fluid pressure. Have a container ready to catch the drainage.
4. Shut off the air supply to the pump.
5. Back out center section regulator to relieve air pressure in center section.

## Pump Shutdown

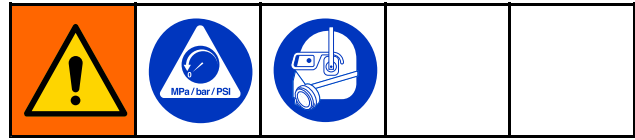

At the end of the work shift and before you check, adjust, clean, or repair the system, follow the [Pressure Relief Procedure, page 20](#).

# VFD Operation

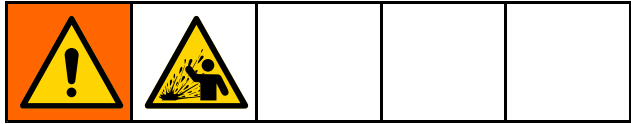

## VFD Control Panel

**NOTE:** This information is specific to Graco's VFD. For complete information about another manufacturer's VFD, see the manufacturer's instructions supplied with the VFD.

- The control panel display shows the status of the motor.
- The green RUN key starts the motor.
- The red STOP key stops the motor.
- Use the arrow keys to speed up or slow down the motor.
- The blue M key accesses the VFD menu. See the manufacturer's instructions for menu descriptions and information.

**NOTE:** If the M key is pressed, use the arrow keys to scroll through the VFD menu.







Figure 11 VFD Control Panel

## Adjust the Speed

VFD settings are preset at the factory for most applications. To change the speed of the pump, use the arrow keys on the VFD control panel to increase or decrease the motor speed.

# Maintenance

				
<p>To avoid injury from fire, explosion, or electric shock, all electrical wiring must be done by a qualified electrician and comply with all local codes and regulations.</p>				

## Maintenance Schedule

Establish a preventive maintenance schedule based on the pump's service history. Scheduled maintenance is especially important to prevent spills or leakage due to diaphragm failure.

## Lubrication

The pump is lubricated at the factory. It is designed to require no further lubrication for the life of the bearings. There is no need to add an inline lubricator under normal operating conditions.

## Tighten Connections

Before each use, check all hoses for wear or damage and replace as necessary. Check to be sure all connections are tight and leak-free. Check mounting bolts.

## Flushing and Storage

				
<p>To avoid injury from fire, explosion, or electric shock, always ground equipment and waste container. To avoid static sparking and injury from splashing, always flush at the lowest possible pressure..</p>				

- Flush before first use.
- Flush at the end of the day, before storing, and before repairing equipment.
- Flush at the lowest pressure possible. Check connectors for leaks and tighten as necessary.
- Flush with a fluid that is compatible with the fluid being dispensed and the equipment wetted parts.
- Always flush the pump and relieve the pressure before storing it for any length of time.

<b><i>NOTICE</i></b>
<p>Flush the pump often enough to prevent the fluid you are pumping from drying or freezing in the pump and damaging it. Store the pump at 32°F (0°C) or higher. Exposure to extreme low temperatures may result in damage to plastic parts.</p>

# Performance Charts

**Test Conditions:** The pump was tested in water with the inlet submerged. The air pressure was set at 100 psi (6.9 bar).

2. Set the VFD frequency corresponding to the desired flow rate. Flow rates will increase with outlet pressure lower than 10 psi (0.7 bar) and with high inlet head pressure.

## How to Use the Charts

1. Choose a flow rate and outlet pressure that falls below the Power Limit Curve. Conditions outside of the curve will decrease the life of the pump.

## High speed gear ratio pumps with gearmotor and compressor (04), (05), or (06)

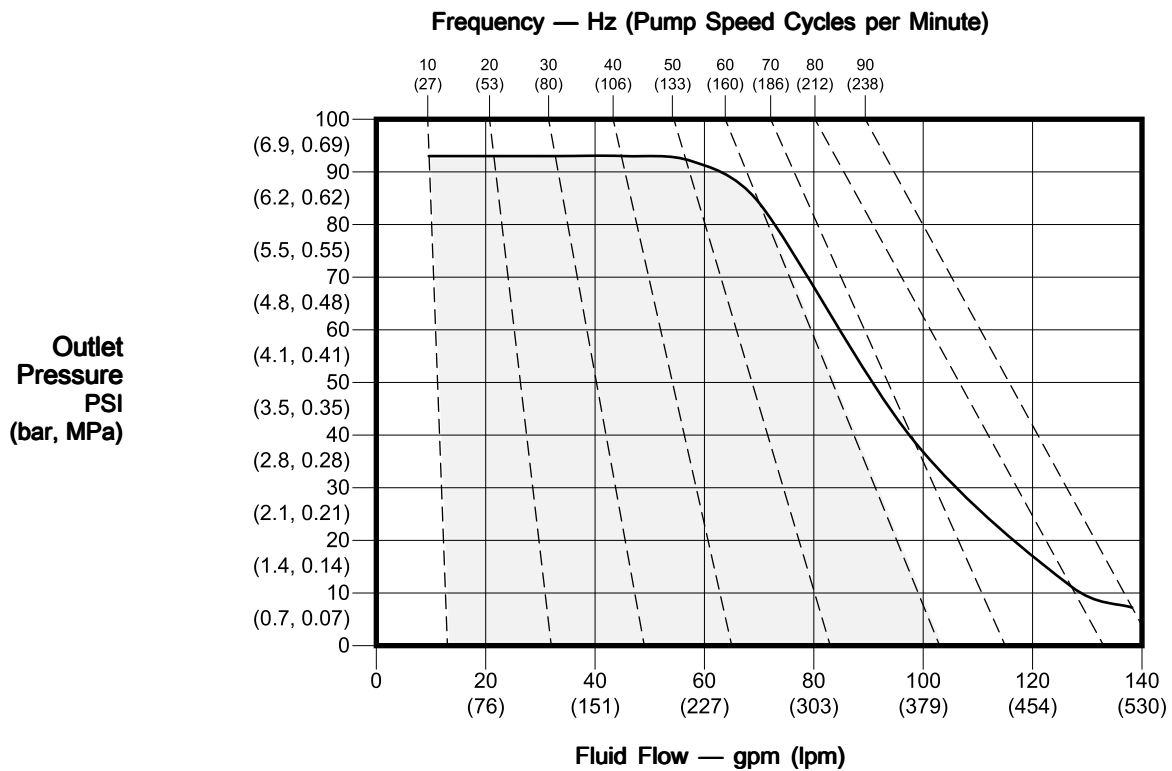

**Medium speed gear ratio pumps with gearmotor and compressor (14), (15), or (16)**

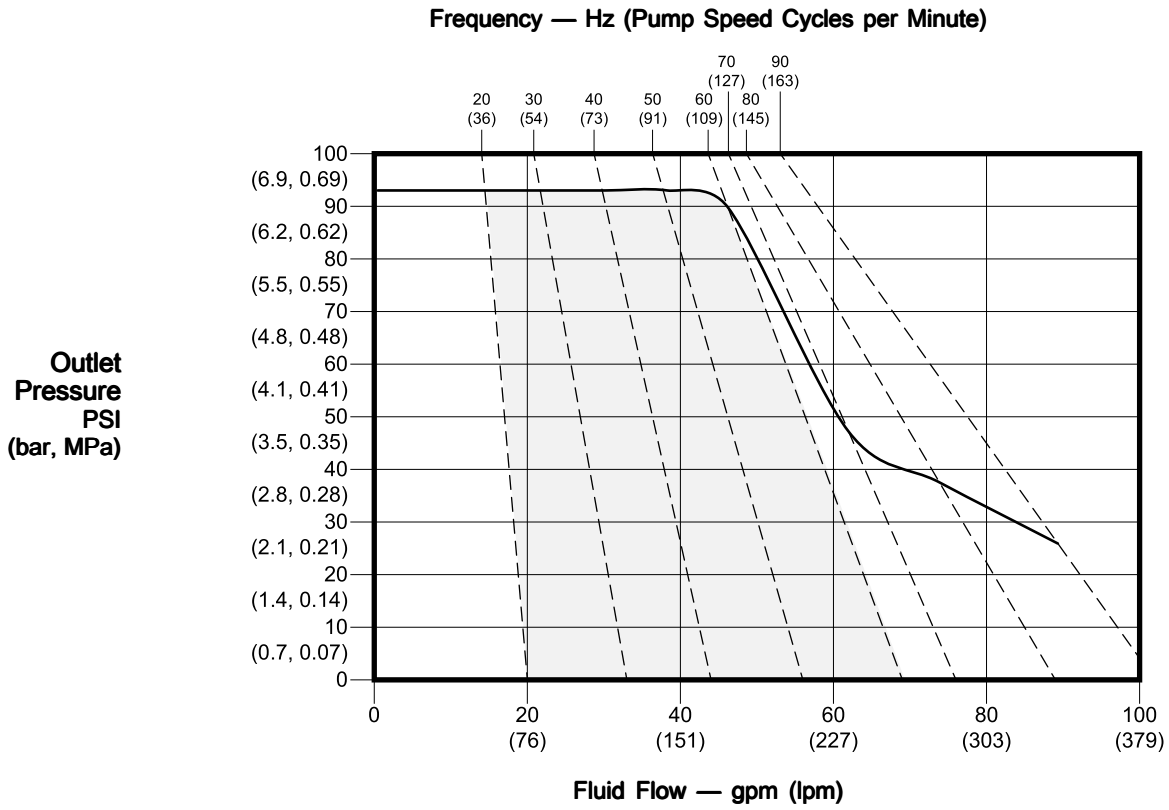

Low speed gear ratio pumps with gearmotor and compressor (24), (25), or (26)

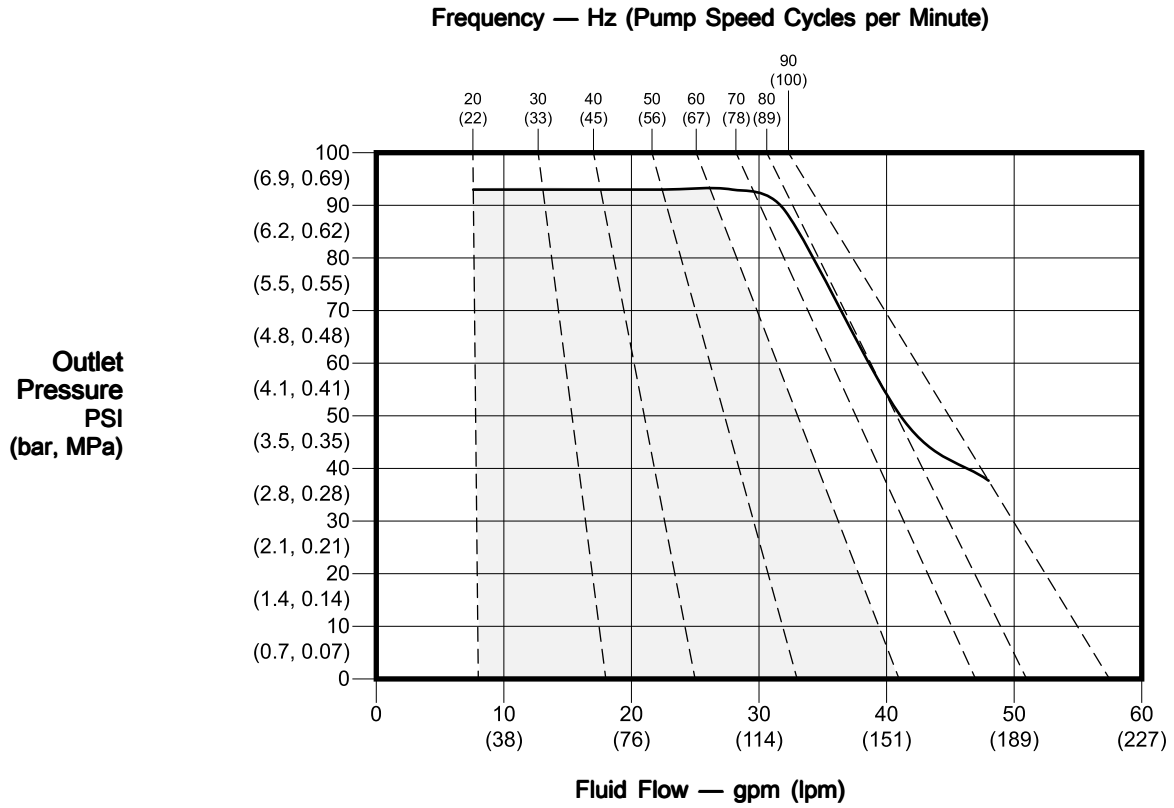

# Dimensions

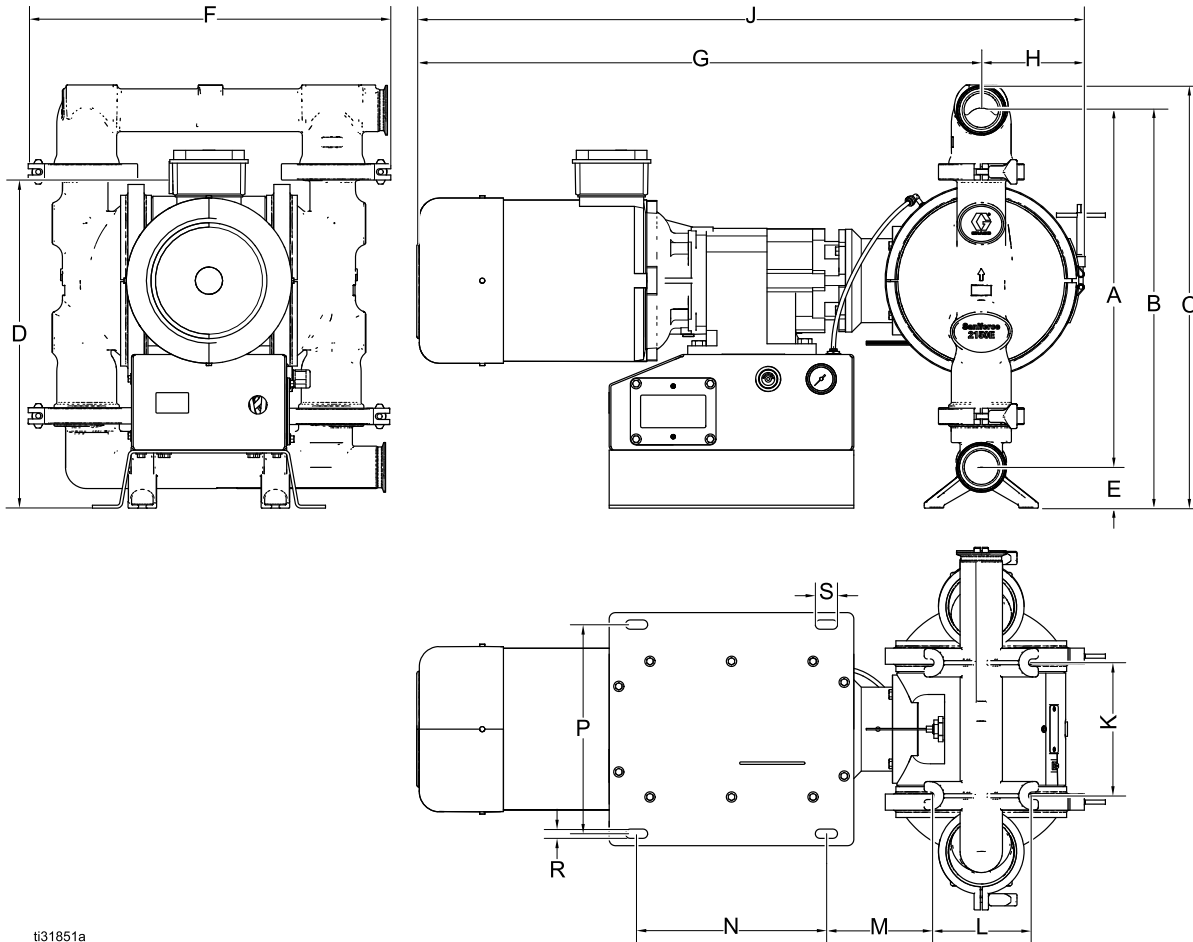

ti31851a

Stainless steel pump with compressor

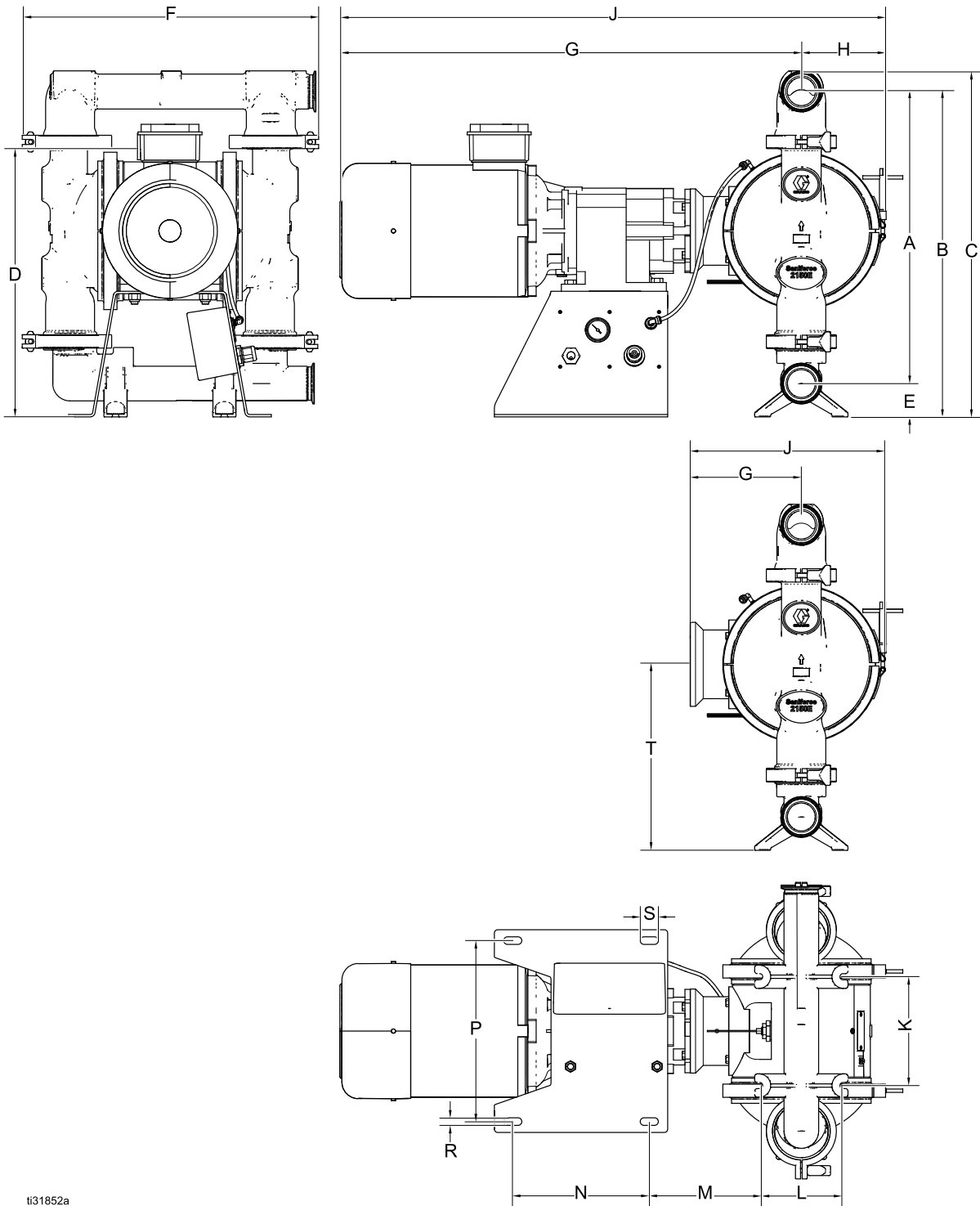

t31852a

Stainless steel pump without compressor

Table 1 Dimensions for SaniForce Pumps

Ref.	Motor and Gearbox Code – Dimensions shown in inches (cm)												
	03G	04A	05A, 06A	14A	15A, 16A	24A	25A, 26A	04C	14C	24C	04D	14D	24D
<b>A</b>	21.9 (55.6)	21.9 (55.6)	21.9 (55.6)	21.9 (55.6)	21.9 (55.6)	21.9 (55.6)	21.9 (55.6)	21.9 (55.6)	21.9 (55.6)	21.9 (55.6)	21.9 (55.6)	21.9 (55.6)	21.9 (55.6)
<b>B</b>	24.4 (11.2)	24.4 (11.2)	24.4 (11.2)	24.4 (11.2)	24.4 (11.2)	24.4 (11.2)	24.4 (11.2)	24.4 (11.2)	24.4 (11.2)	24.4 (11.2)	24.4 (11.2)	24.4 (11.2)	24.4 (11.2)
<b>C</b>	26.0 (66.0)	26.0 (66.0)	26.0 (66.0)	26.0 (66.0)	26.0 (66.0)	26.0 (66.0)	26.0 (66.0)	26.0 (66.0)	26.0 (66.0)	26.0 (66.0)	26.0 (66.0)	26.0 (66.0)	26.0 (66.0)
<b>D</b>	---	20.2 (51.3)	20.2 (51.3)	19.4 (49.3)	19.4 (49.3)	19.0 (48.3)	19.0 (48.3)	21.2 (53.8)	20.4 (51.8)	20.4 (51.8)	13.5 (34.3)	13.9 (35.3)	10.4 (26.4)
<b>E</b>	2.5 (6.4)	2.5 (6.4)	2.5 (6.4)	2.5 (6.4)	2.5 (6.4)	2.5 (6.4)	2.5 (6.4)	2.5 (6.4)	2.5 (6.4)	2.5 (6.4)	2.5 (6.4)	2.5 (6.4)	2.5 (6.4)
<b>F</b>	22.0 (55.9)	22.0 (55.9)	22.0 (55.9)	22.0 (55.9)	22.0 (55.9)	22.0 (55.9)	22.0 (55.9)	22.0 (55.9)	22.0 (55.9)	22.0 (55.9)	22.0 (55.9)	22.0 (55.9)	22.0 (55.9)
<b>G</b>	8.3 (21.1)	34.6 (87.9)	34.6 (87.9)---	32.2 (81.8)	32.2 (81.8)---	30.4 (77.2)	30.4 (77.2)---	41.4 (105.2)	34.9 (88.6)	33.9 (86.1)	43.8 (111.3)	37.5 (95.3)	37.4 (95.0)
<b>H</b>	6.3 (16.0)	6.3 (16.0)	6.3 (16.0)	6.3 (16.0)	6.3 (16.0)	6.3 (16.0)	6.3 (16.0)	6.3 (16.0)	6.3 (16.0)	6.3 (16.0)	6.3 (16.0)	6.3 (16.0)	6.3 (16.0)
<b>J</b>	14.6 (37.1)	40.9 (103.9)	40.9 (103.9)---	38.5 (97.8)	38.5 (97.8)---	36.6 (93.0)	36.6 (93.0)---	47.7 (121.2)	41.2 (104.6)	40.2 (102.1)	50.1 (127.3)	43.7 (111.0)	43.7 (111.0)
<b>K</b>	8.2 (20.8)	8.2 (20.8)	8.2 (20.8)	8.2 (20.8)	8.2 (20.8)	8.2 (20.8)	8.2 (20.8)	8.2 (20.8)	8.2 (20.8)	8.2 (20.8)	8.2 (20.8)	8.2 (20.8)	8.2 (20.8)
<b>L</b>	6.3 (16.0)	6.3 (16.0)	6.3 (16.0)	6.3 (16.0)	6.3 (16.0)	6.3 (16.0)	6.3 (16.0)	6.3 (16.0)	6.3 (16.0)	6.3 (16.0)	6.3 (16.0)	6.3 (16.0)	6.3 (16.0)
<b>M</b>	---	8.3 (21.1)	6.4 (16.3)	8.3 (21.1)	6.4 (16.3)	8.3 (21.1)	6.4 (16.3)	8.3 (21.1)	8.3 (21.1)	8.3 (21.1)	8.3 (21.1)	8.3 (21.1)	8.3 (21.1)
<b>N</b>	---	10.2 (25.9)	11.6 (29.5)	10.2 (25.9)	11.6 (29.5)	10.2 (25.9)	11.6 (29.5)	10.2 (25.9)	10.2 (25.9)	10.2 (25.9)	10.2 (25.9)	10.2 (25.9)	10.2 (25.9)
<b>P</b>	---	13.6 (34.5)	12.8 (32.5)	13.6 (34.5)	12.8 (32.5)	13.6 (34.5)	12.8 (32.5)	12.8 (32.5)	12.8 (32.5)	12.8 (32.5)	12.8 (32.5)	12.8 (32.5)	12.8 (32.5)
<b>R</b>	---	0.6 (1.5)	0.6 (1.5)	0.6 (1.5)	0.6 (1.5)	0.6 (1.5)	0.6 (1.5)	0.6 (1.5)	0.6 (1.5)	0.6 (1.5)	0.6 (1.5)	0.6 (1.5)	0.6 (1.5)
<b>S</b>	---	1.4 (3.6)	1.4 (3.6)	1.4 (3.6)	1.4 (3.6)	1.4 (3.6)	1.4 (3.6)	1.4 (3.6)	1.4 (3.6)	1.4 (3.6)	1.4 (3.6)	1.4 (3.6)	1.4 (3.6)
<b>T</b>	13.9 (35.3)	---	---	---	---	---	---	---	---	---	---	---	---

# Technical Data

<b>SaniForce Electric Double Diaphragm Pump</b>		
	<b>US</b>	<b>Metric</b>
Maximum fluid working pressure	100 psi	0.69 MPa, 6.9 bar
Air pressure operating range	20 to 100 psi	0.14 to 0.69 MPa, 1.4 to 6.9 bar
Air inlet size	3/8 in. npt(f)	
Maximum suction lift (reduced if balls don't seat well due to damaged balls or seats, lightweight balls, or extreme speed of cycling)	Wet or Dry: 18 ft	Wet or Dry: 5.5 m
Maximum size pumpable solids	1/4 in.	6.3 mm
Minimum ambient air temperature for operation and storage. <b>NOTE:</b> Exposure to extreme low temperatures may result in damage to plastic parts.	32° F	0° C
Fluid displacement per cycle (free-flow)	0.6 gallons	2.27 liters
Maximum free-flow delivery (continuous duty)	100 gpm	378 lpm
Maximum pump speed (continuous duty)	160 cpm	
<b>Fluid Inlet and Outlet Size</b>		
Stainless Steel	2.5 in sanitary flange or 65 mm DIN 11851	
<b>Electric Motor</b>		
AC, Standard CE (04A, 05A, 06A)		
Power	7.5 HP	5.5 kW
Number of Motor Poles	4-Pole	
Speed	1800 rpm (60 Hz) or 1500 rpm (50 Hz)	
Constant Torque	6:1	
Gear Ratio	11.25	
Voltage	3-phase 230V / 3-Phase 460V	
Maximum Amperage Load	19.5 A (230V) / 9.75 A (460V)	
IE Rating	IE3	
AC, Standard CE (14A, 15A, 16A)		
Power	5.0 HP	3.7 kW
Number of Motor Poles	4-Pole	
Speed	1800 rpm (60 Hz) or 1500 rpm (50 Hz)	
Constant Torque	6:1	
Gear Ratio	16.46	
Voltage	3-phase 230V / 3-Phase 460V	
Maximum Amperage Load	13.0 A (230V) / 6.5 A (460V)	
AC, Standard CE (24A, 25A, 26A)		
Power	3.0 HP	2.2 kW
Number of Motor Poles	4-Pole	
Speed	1800 rpm (60 Hz) or 1500 rpm (50 Hz)	
Constant Torque	6:1	
Gear Ratio	26.77	

Technical Data

Voltage	3-phase 230V / 3-Phase 460V	
Maximum Amperage Load	7.68 A (230V) / 3.84 A (460V)	
IE Rating	IE3	
AC, ATEX (04C)		
Power	7.5 HP	5.5 kW
Number of Motor Poles	4-Pole	
Speed	1800 rpm (60 Hz) or 1500 rpm (50 Hz)	
Constant Torque	6:1	
Gear Ratio	11.88	
Voltage	3-phase 240V / 3-Phase 415V	
Maximum Amperage Load	20 A (230V) / 11.5 A (460V)	
AC, ATEX (14C)		
Power	5.0 HP	4.0 kW
Number of Motor Poles	4-Pole	
Speed	1800 rpm (60 Hz) or 1500 rpm (50 Hz)	
Constant Torque	6:1	
Gear Ratio	16.46	
Voltage	3-phase 240V / 3-Phase 415V	
Maximum Amperage Load	14.7 A (230V) / 8.5 A (460V)	
AC, ATEX (24C)		
Power	3.0 HP	2.2 kW
Number of Motor Poles	4-Pole	
Speed	1800 rpm (60 Hz) or 1500 rpm (50 Hz)	
Constant Torque	6:1	
Gear Ratio	26.77	
Voltage	3-phase 240V / 3-Phase 415V	
Maximum Amperage Load	8.5 A (230V) / 5.0 A (460V)	
AC, Explosionproof (04D)		
Power	7.5 Hp	5.5 kW
Number of Motor Poles	4-Pole	
Speed	1800 rpm (60 Hz) or 1500 rpm (50 Hz)	
Constant Torque	6:1	
Gear Ratio	11.88	
Voltage	3-phase 230V / 3-Phase 460V	
Maximum Amperage Load	20.0 A (230V) / 10.0 A (460V)	
AC, Explosionproof (14D)		
Power	5.0 Hp	3.7 kW
Number of Motor Poles	4-Pole	
Speed	1800 rpm (60 Hz) or 1500 rpm (50 Hz)	
Constant Torque	6:1	
Gear Ratio	16.46	
Voltage	3-phase 230V / 3-Phase 460V	
Maximum Amperage Load	13.0 A (230V) / 6.5 A (460V)	

AC, Explosionproof (24D)		
Power	3.0 Hp	2.2 kW
Number of Motor Poles	4-Pole	
Speed	1800 rpm (60 Hz) or 1500 rpm (50 Hz)	
Constant Torque	6:1	
Gear Ratio	26.77	
Voltage	3-phase 230V / 3-Phase 460V	
Maximum Amperage Load	8 A (230V) / 4 A (460V)	
Leak Sensor		
Contact Ratings:		
State	Normally closed	
Voltage	240V Max (AC/DC)	
Current	0.28 A max at 120 VAC 0.14 A max at 240 VAC 0.28 A max at 24 VDC 0.07 A max at 120 VDC	
Power	30 W max	
Ambient Temperature	-20° to 40°C (-4° to 104°F)	
Ex Ratings:		
Classification: "simple apparatus" in accordance with UL/EN/IEC 60079-11, clause 5.7		
Class I, Group D, Class II, Group F&G, Temp Code T3B		
		
II 2 G Ex ib IIC T3		
Parameters	$U_i = 24\text{ V}$ $I_i = 280\text{ mA}$ $P_i = 1.3\text{ W}$ $C_i = 2.4\text{ pF}$ $L_i = 1.00\text{ }\mu\text{H}$	
<b>Noise Data</b>		
Sound Power (measured per ISO-9614-2)		
at 90 psi fluid pressure and 80 cpm	84 dBa	
at 60 psi fluid pressure and 160 cpm (full flow)	92 dBa	
Sound Pressure [tested 3.28 ft (1 m) from equipment]		
at 90 psi fluid pressure and 80 cpm	74 dBa	
at 60 psi fluid pressure and 160 cpm (full flow)	82 dBa	
<b>Wetted Parts</b>		
Wetted parts include material(s) chosen for seat, ball, and diaphragm options, <b>plus the pump's material of construction: Aluminum, Polypropylene, Stainless Steel, Conductive Polypropylene, or PVDF</b>		
Non-wetted parts		
Non-wetted parts include aluminum, coated carbon steel, PTFE, stainless steel, polypropylene		

Pump Material	Motor/Gearbox																			
	Standard AC						ATEX AC						Flameproof AC						No Gear-motor	
Center Section	04A		14A		24A		04C		14C		24C		04D		14D		24D		03G	
	lb	kg	lb	kg	lb	kg	lb	kg	lb	kg	lb	kg	lb	kg	lb	kg	lb	kg	lb	kg
Aluminum	360	163	328	149	308	140	498	226	351	159	325	147	520	236	427	194	418	190	200	91
Stainless Steel	442	200	410	186	390	177	580	263	433	196	407	185	602	273	508	231	500	227	282	128

Variable Frequency Drives (2 hp)

Model	Hp/kW	Input Voltage Range	Nominal Output Voltage †
17K696	3.0/2.2	170–264 Vac	208–240 Vac, 3 phase
17K697	3.0/2.2	340–528 Vac	400–480 Vac, 3 phase
25B446	5.0/4.0	170–264 Vac	208–240 Vac, 3 phase
25B447	5.0/4.0	340–528 Vac	400–480 Vac, 3 phase
25B448	7.5/5.5	170–264 Vac	208–240 Vac, 3 phase
25B449	7.5/5.5	340–528 Vac	400–480 Vac, 3 phase

† Output voltage is dependent on input voltage.

Component/Model	U.S.	Metric
Compressor	28 lb	13 kg

### Fluid Temperature Range

<b>NOTICE</b>
Temperature limits are based on mechanical stress only. Certain chemicals will further limit the fluid temperature range. Stay within the temperature range of the most-restricted wetted component. Operating at a fluid temperature that is too high or too low for the components of your pump may cause equipment damage.

Diaphragm/Ball/Seat Material	Stainless Steel Pump Fluid Temperature Range	
	Fahrenheit	Celsius
Polychloroprene check balls (CW)	0° to 180°F	-18° to 82°C
PTFE overmolded diaphragm (PO)	40° to 180°F	4° to 82°C
PTFE check balls or two-piece PTFE/EPDM diaphragm (PT)	40° to 220°F	4° to 104°C

\* The maximum temperature listed is based on the ATEX standard for T4 temperature classification.

# Graco Standard Warranty

Graco warrants all equipment referenced in this document which is manufactured by Graco and bearing its name to be free from defects in material and workmanship on the date of sale to the original purchaser for use. With the exception of any special, extended, or limited warranty published by Graco, Graco will, for a period of twelve months from the date of sale, repair or replace any part of the equipment determined by Graco to be defective. This warranty applies only when the equipment is installed, operated and maintained in accordance with Graco's written recommendations.

This warranty does not cover, and Graco shall not be liable for general wear and tear, or any malfunction, damage or wear caused by faulty installation, misapplication, abrasion, corrosion, inadequate or improper maintenance, negligence, accident, tampering, or substitution of non-Graco component parts. Nor shall Graco be liable for malfunction, damage or wear caused by the incompatibility of Graco equipment with structures, accessories, equipment or materials not supplied by Graco, or the improper design, manufacture, installation, operation or maintenance of structures, accessories, equipment or materials not supplied by Graco.

This warranty is conditioned upon the prepaid return of the equipment claimed to be defective to an authorized Graco distributor for verification of the claimed defect. If the claimed defect is verified, Graco will repair or replace free of charge any defective parts. The equipment will be returned to the original purchaser transportation prepaid. If inspection of the equipment does not disclose any defect in material or workmanship, repairs will be made at a reasonable charge, which charges may include the costs of parts, labor, and transportation.

**THIS WARRANTY IS EXCLUSIVE, AND IS IN LIEU OF ANY OTHER WARRANTIES, EXPRESS OR IMPLIED, INCLUDING BUT NOT LIMITED TO WARRANTY OF MERCHANTABILITY OR WARRANTY OF FITNESS FOR A PARTICULAR PURPOSE.**

Graco's sole obligation and buyer's sole remedy for any breach of warranty shall be as set forth above. The buyer agrees that no other remedy (including, but not limited to, incidental or consequential damages for lost profits, lost sales, injury to person or property, or any other incidental or consequential loss) shall be available. Any action for breach of warranty must be brought within two (2) years of the date of sale..

**GRACO MAKES NO WARRANTY, AND DISCLAIMS ALL IMPLIED WARRANTIES OF MERCHANTABILITY AND FITNESS FOR A PARTICULAR PURPOSE, IN CONNECTION WITH ACCESSORIES, EQUIPMENT, MATERIALS OR COMPONENTS SOLD BUT NOT MANUFACTURED BY GRACO.** These items sold, but not manufactured by Graco (such as electric motors, switches, hose, etc.), are subject to the warranty, if any, of their manufacturer. Graco will provide purchaser with reasonable assistance in making any claim for breach of these warranties..

In no event will Graco be liable for indirect, incidental, special or consequential damages resulting from Graco supplying equipment hereunder, or the furnishing, performance, or use of any products or other goods sold hereto, whether due to a breach of contract, breach of warranty, the negligence of Graco, or otherwise.

## FOR GRACO CANADA CUSTOMERS

The Parties acknowledge that they have required that the present document, as well as all documents, notices and legal proceedings entered into, given or instituted pursuant hereto or relating directly or indirectly hereto, be drawn up in English. Les parties reconnaissent avoir convenu que la rédaction du présente document sera en Anglais, ainsi que tous documents, avis et procédures judiciaires exécutés, donnés ou intentés, à la suite de ou en rapport, directement ou indirectement, avec les procédures concernées.

## Graco Information

For the latest information about Graco products, visit [www.graco.com](http://www.graco.com).  
For patent information, see [www.graco.com/patents](http://www.graco.com/patents).

**To place an order**, contact your Graco Distributor or call to identify the nearest distributor.

**Phone:** 612-623-6921 **or Toll Free:** 1-800-328-0211 **Fax:** 612-378-3505

All written and visual data contained in this document reflects the latest product information available at the time of publication.

Graco reserves the right to make changes at any time without notice.  
Original Instructions. This manual contains English. MM 3A5132

**Graco Headquarters:** Minneapolis  
**International Offices:** Belgium, China, Japan, Korea

**GRACO INC. AND SUBSIDIARIES • P.O. BOX 1441 • MINNEAPOLIS MN 55440-1441 • USA**  
**Copyright 2017, Graco Inc. All Graco manufacturing locations are registered to ISO 9001.**

[www.graco.com](http://www.graco.com)  
Revision C, February 2018